

# Razvodni ormari

## Pravi izbor za P/Ž i N/Ž ugradnju

Ovdje odlučuju „unutrašnje vrijednosti“: Univerzalni razdjelni ormar od 36 do 336 modularnih mjesta je inteligentno instalaciono rješenje za poslovne i javne objekte. Zahvaljujući naprednom sistemu unutrašnje izgradnje, ormar univers vrlo jednostavno ispunjava sve zahtjeve vašeg poslodavca, kad su spratni i razdjelni ormari u pitanju. Na primjer u stanogradnji: zahvaljujući dubini od samo 110mm, P/Ž ormar se može ugraditi u svaki zid i pored toga nudi dovoljno prostora za ugradnju modularne opreme i multimedijalnih uređaja, koji se najčešće koriste u stanogradnji (kablovska TV, internet, multiswitch oprema).



univers N - razvodni ormari IP44 / zaštitna klasa II	50
univers - razvodni ormari IP31 sa multimedijalnim poljem	51
univers P/Ž - razvodni ormari IP30 / zaštitna klasa II	52
univers P/Ž - razvodni ormari IP31 sa multimedijalnim poljem	53
orion.tech - ormari za automatizaciju IP65 od čeličnog lima	60
orion plus - zidni ormari od čeličnog lima IP65	70
orion plus - zidni ormari od poliestera ojačanog staklenim vlaknima IP66	72
orion plus - zidni ormari od poliestera IP65	73
orion plus - samostojeći ormari od poliestera IP65	74
orion.inox	84
quadro5 IP55 630A	86
quadro plus IP55 4000A	92
FK ormari - kompletni samostojeći ormari IP65	116

### univers N

- Za uređaje do 125 A
- Za nadžbuk, podžbuk i djelimično upuštenu montažu
- Dubina 161 mm
- Kompletan razvodni ormar sa vratima, kosturom i modularnim poklopcima
- QuickConnect kleme, dvije N i jedna PE klemna
- Uvodnice za kablove sa gornje i donje strane

### Karakteristike:

- Boja: bijela RAL9010
- Zaštita IP44
- Zaštita od udara IK08
- Zaštitna klasa II
- Otpor kratkog spoja: 17kA
- Visine ormara: 500, 650, 800, 950 i 1100 mm

### Standard: IEC EN 61 439-1/-3



Samogasivi materijal na 850°C prema IEC EN 60 695-2-10 i IEC 60 695-2-11

► Tehničke informacije na stranama 120-121.



FWB31S

### univers N IP44 visine 500 i 650 mm

Redova	Polja	Modula	Dimenzije Š x V x D (mm)	PE/N-kleme	Pak.	Šifra
3	1	36	300 x 500 x 161	2x18	1	<b>FWB31S</b>
	2	72	550 x 500 x 161	2x18	1	<b>FWB32S</b>
	3	108	800 x 500 x 161	2x18	1	<b>FWB33S</b>
	4	144	1050 x 500 x 161	2x18	1	<b>FWB34S</b>
4	1	48	300 x 650 x 161	2x22	1	<b>FWB41S</b>
	2	96	550 x 650 x 161	2x22	1	<b>FWB42S</b>
	3	144	800 x 650 x 161	2x22	1	<b>FWB43S</b>
	4	192	1050 x 650 x 161	2x22	1	<b>FWB44S</b>



FWB53S

### univers N IP44 visine 800 mm

Redova	Polja	Modula	Dimenzije Š x V x D (mm)	PE/N-kleme	Pak.	Šifra
5	1	60	300 x 800 x 161	2x22	1	<b>FWB51S</b>
	2	120	550 x 800 x 161	2x22	1	<b>FWB52S</b>
	3	180	800 x 800 x 161	2x22	1	<b>FWB53S</b>
	4	240	1050 x 800 x 161	2x22	1	<b>FWB54S</b>



FWB62S

### univers N IP44 visine 950 mm

Redova	Polja	Modula	Dimenzije Š x V x D (mm)	PE/N-kleme	Pak.	Šifra
6	1	72	300 x 950 x 161	2x22	1	<b>FWB61S</b>
	2	144	550 x 950 x 161	2x22	1	<b>FWB62S</b>
	3	216	800 x 950 x 161	2x22	1	<b>FWB63S</b>
	4	288	1050 x 950 x 161	2x22	1	<b>FWB64S</b>



FWB71S

### univers N IP44 visine 1100 mm

Redova	Polja	Modula	Dimenzije Š x V x D (mm)	PE/N-kleme	Pak.	Šifra
7	1	84	300 x 1100 x 161	2x22	1	<b>FWB71S</b>
	2	168	550 x 1100 x 161	2x22	1	<b>FWB72S</b>
	3	252	800 x 1100 x 161	2x22	1	<b>FWB73S</b>
	4	336	1050 x 1100 x 161	2x22	1	<b>FWB74S</b>

### univers sa multimedijalnim poljem

- Kompletan ormar sa perforiranim vratima, kosturom, modularnim poklopcima i perforiranom montažnom pločom
- Za uređaje do 125 A
- Dubina 161 mm
- QuickConnect klemme, dvije N i jedna PE klema
- Demontažne uvodnice za kablove sa gornje i donje strane

### Karakteristike

- Boja: bijela RAL9010
- Zaštita IP31
- Širine ormara: 500 i 800 mm
- Visine ormara: 500, 650, 800, 950 i 1100 mm
- Broj modula: od 36 do 144
- Moguća ugradnja multimedijalnih setova UM00M1 i UM00M2

### Standard: IEC EN 61 439-1/-3



Samogasivi materijal na 850°C prema IEC EN 60 695-2-10 i IEC 60 695-2-11

### univers sa multimedijalnim poljem IP31, širina ormara 550 mm

Redova	Br. polja	Modula	Dimenzije Š x V x D (mm)	Pak.	Šifra
3	2	36	550 x 500 x 161	1	★ FWB32K1
4	2	48	550 x 650 x 161	1	★ FWB42K1
5	2	60	550 x 800 x 161	1	★ FWB52K1
6	2	72	550 x 950 x 161	1	★ FWB62K1
7	2	84	550 x 1100 x 161	1	★ FWB72K1



FWB52K1

### univers sa multimedijalnim poljem IP31 i IP44, širina ormara 800 mm

Redova	Br. polja	Modula	Dimenzije Š x V x D (mm)	IP zaštita	Pak.	Šifra
5	3	120	800 x 800 x 161	IP31	1	★ FWB53K1
6	3	144	800 x 950 x 161	IP44	1	★ FWB63K1



FWB63K1

### Multimedijalni setovi

Opis	Pak.	Šifra
Multimedijalni set za univers, 3-struka utičnica, patch-panel sa 6xRJ45	1	★ UM00M1
Multimedijalni set za univers, 3-struka utičnica, patch-panel, prazan	1	★ UM00M2
Multimedijalni set za univers, 3-struka utičnica, patch-panel za 24xRJ45	1	★ UM00M4



UM00M1

### Patch-panel za 10 konektora RJ45, za 2 Integro flow utičnice

Opis	Pak.	Šifra
Patch-panel za 10xRJ45 i 2xberker integro flow utičnice (250 x 40 V x Š mm)	1	★ UM00K3



UM00K3

### Patch-panel za komunikacijski modul

Opis	Pak.	Šifra
Patch-panel za ugradnju 24 komunikacijska modula kao: RJ45, LWL, Koax (250 x 40 V x Š mm)	1	★ UM00K4



UM00K4



### univers za P/Ž montažu i šuplje zidove

- Za uređaje do 125 A
- za podžbuk i montažu u šuplje zidove
- Dubina 110 mm
- Kompletan razvodni ormar sa vratima, kosturom i modularnim poklopcima
- QuickConnect klemme, dvije N i jedna PE klema
- Uvodnice za kablove sa gornje i donje strane

### Karakteristike:

- Ravan okvir
- Integrisane prihvatne šine za kablove
- Boja: bijela RAL9010
- Zaštita IP44
- Zaštitna klasa II
- Visine ormara: 500, 650, 800, 950 i 1100 mm

Standard: IEC EN 61 439-1/-3

► Tehničke informacije na strani 122.



FWU43S

### univers P/Ž IP30, visine 500 i 650 mm

Redova	Polja	Modula	Dimenzije Š x V x D (mm)	PE/N-kleme	Pak.	Šifra
3	1	36	300 x 500 x 110	2x10N 1x18PE	1	★ FWU31S
	2	72	550 x 500 x 110	2x10N 1x18PE	1	★ FWU32S
	3	108	800 x 500 x 110	2x10N 1x18PE	1	★ FWU33S
4	1	48	300 x 650 x 110	2x10N 1x22PE	1	★ FWU41S
	2	96	550 x 650 x 110	2x10N 1x22PE	1	★ FWU42S
	3	144	800 x 650 x 110	2x10N 1x22PE	1	★ FWU43S



FWU52S

### univers P/Ž IP30, visine 800 mm

Redova	Polja	Modula	Dimenzije Š x V x D (mm)	PE/N-kleme	Pak.	Šifra
5	1	60	300 x 800 x 110	2x10N 1x22PE	1	★ FWU51S
	2	120	550 x 800 x 110	2x10N 1x22PE	1	★ FWU52S
	3	180	800 x 800 x 110	2x10N 1x22PE	1	★ FWU53S



FWU61S

### univers P/Ž IP30, visine 950 mm

Redova	Polja	Modula	Dimenzije Š x V x D (mm)	PE/N-kleme	Pak.	Šifra
6	1	72	300 x 950 x 110	2x10N 1x22PE	1	★ FWU61S
	2	144	550 x 950 x 110	2x10N 1x22PE	1	★ FWU62S
	3	216	800 x 950 x 110	2x10N 1x22PE	1	★ FWU63S



FWU73S

### univers P/Ž IP30, visine 1100 mm

Redova	Polja	Modula	Dimenzije Š x V x D (mm)	PE/N-kleme	Pak.	Šifra
7	1	84	300 x 1100 x 110	2x10N 1x22PE	1	★ FWU71S
	2	168	550 x 1100 x 110	2x10N 1x22PE	1	★ FWU72S
	3	252	800 x 1100 x 110	2x10N 1x22PE	1	★ FWU73S

### univers P/Ž sa multimedijalnim poljem IP31, širina ormara 550 mm

Redova	Br. polja	Modula	Dimenzije Š x V x D (mm)	PE/N-kleme	Pak.	Šifra
3	2	36	550 x 500 x 110	2x10N 1x18PE	1	★ FWU32K1
4	2	48	550 x 650 x 110	2x10N 1x22PE	1	★ FWU42K1
5	2	60	550 x 800 x 110	2x10N 1x22PE	1	★ FWU52K1
6	2	72	550 x 950 x 110	2x10N 1x22PE	1	★ FWU62K1
7	2	84	550 x 1100 x 110	2x10N 1x22PE	1	★ FWU72K1



FWU62K1

Razvodni ormari

### Telekomunikacijski perforirani paneli (perforirani lim)

Br. polja	Dimenzije Š x V (mm)	Pak.	Šifra
1	250 x 450	1	UN31TN
2	500 x 450	1	UN32TN
1	250 x 600	1	UN41TN
2	500 x 600	1	UN42TN
1	250 x 750	1	UN51TN
2	500 x 750	1	UN52TN
1	250 x 900	1	UN61TN
2	500 x 900	1	UN62TN
1	250 x 1050	1	UN71TN
2	500 x 1050	1	UN72TN



UN62TN

### Multimedijalna ploča od PVC materijala

Redova	Dimenzije Š x V (mm)	Pak.	Šifra
3	250 x 450	1	UM31UK
4	250 x 600	1	UM41UK
5	250 x 750	1	UM51UK
6	250 x 900	1	UM61UK
7	250 x 1050	1	UM71UK
8	250 x 1250	1	UM81UK
Multimedijalna PVC perforirana ploča	247 x 175	1	UM00M0

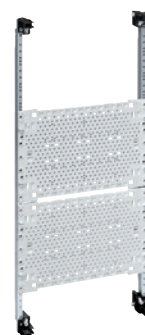

UM41UK

### Multimedijalna perforirana vrata (metalni okvir, plastični umetak)

Opis	Dimenzije Š x V (mm)	Pak.	Šifra
Desna vrata, multimedija, univers	550 x 500	1	★ FZ002NM
Desna vrata, multimedija, univers	300 x 650	1	★ FZ005NM
Desna vrata, multimedija, univers	550 x 650	1	★ FZ006NM
Lijeva vrata, multimedija, univers	800 x 650	1	★ FZ007NM
Desna vrata, multimedija, univers	300 x 800	1	★ FZ009NM
Desna vrata, multimedija, univers	550 x 800	1	★ FZ010NM
Lijeva vrata, multimedija, univers	800 x 800	1	★ FZ011NM
Desna vrata, multimedija, univers	300 x 950	1	★ FZ013NM
Desna vrata, multimedija, univers	550 x 950	1	★ FZ014NM
Desna vrata, multimedija, univers	300 x 1100	1	★ FZ021NM
Desna vrata, multimedija, univers	550 x 1100	1	★ FZ022NM
Desna vrata, multimedija, univers	300 x 1250	1	★ FZ026NM



FZ005NM



FWB31D

**univers N/Ž razvodni ormar, prazan sa vratima IP44, visine 500 i 650 mm**

Redova	Polja	Modula	Dimenzije Š x V x D (mm)	Pak.	Šifra
3	1	36	300 x 500 x 161	1	<b>FWB31D</b>
	2	72	550 x 500 x 161	1	<b>FWB32D</b>
	3	108	800 x 500 x 161	1	<b>FWB33D</b>
	4	144	1050 x 500 x 161	1	<b>FWB34D</b>
4	1	48	300 x 650 x 161	1	<b>FWB41D</b>
	2	96	550 x 650 x 161	1	<b>FWB42D</b>
	3	144	800 x 650 x 161	1	<b>FWB43D</b>
	4	192	1050 x 650 x 161	1	<b>FWB44D</b>



FWB53D

**univers N/Ž razvodni ormar, prazan sa vratima, visine 800 mm**

Redova	Polja	Modula	Dimenzije Š x V x D (mm)	Pak.	Šifra
5	1	60	300 x 800 x 161	1	<b>FWB51D</b>
	2	120	550 x 800 x 161	1	<b>FWB52D</b>
	3	180	800 x 800 x 161	1	<b>FWB53D</b>
	4	240	1050 x 800 x 161	1	<b>FWB54D</b>



FWB61D

**univers N/Ž razvodni ormar, prazan sa vratima, visine 950 mm**

Redova	Polja	Modula	Dimenzije Š x V x D (mm)	Pak.	Šifra
6	1	72	300 x 950 x 161	1	<b>FWB61D</b>
	2	144	550 x 950 x 161	1	<b>FWB62D</b>
	3	216	800 x 950 x 161	1	<b>FWB63D</b>
	4	288	1050 x 950 x 161	1	<b>FWB64D</b>



FWB71S

**univers N/Ž razvodni ormar, prazan sa vratima IP44, visine 1100 mm**

Redova	Polja	Modula	Dimenzije Š x V x D (mm)	Pak.	Šifra
7	1	84	300 x 1100 x 161	1	<b>FWB71D</b>
	2	168	550 x 1100 x 161	1	<b>FWB72D</b>
	3	252	800 x 1100 x 161	1	<b>FWB73D</b>
	4	336	1050 x 1100 x 161	1	<b>FWB74D</b>

**univers N/Ž razvodni ormar, prazan sa vratima IP44, visine 1250 mm**

Redova	Polja	Modula	Dimenzije Š x V x D (mm)	Pak.	Šifra
8	1	96	300 x 1250 x 161	1	<b>FWB81D</b>

### univers N/Ž razvodni ormar, prazan bez vrata IP30, visine 500 i 650 mm

Redova	Polja	Modula	Dimenzije Š x V x D (mm)	Pak.	Šifra
3	1	36	300 x 500 x 161	1	<b>FWB31D1</b>
	2	72	550 x 500 x 161	1	<b>FWB32D1</b>
	3	108	800 x 500 x 161	1	<b>FWB33D1</b>
	4	144	1050 x 500 x 161	1	<b>FWB34D1</b>
4	1	48	300 x 650 x 161	1	<b>FWB41D1</b>
	2	96	550 x 650 x 161	1	<b>FWB42D1</b>
	3	144	800 x 650 x 161	1	<b>FWB43D1</b>
	4	192	1050 x 650 x 161	1	<b>FWB44D1</b>



FWB31D1

### univers N/Ž razvodni ormar, prazan bez vrata IP30, visine 800 mm

Redova	Polja	Modula	Dimenzije Š x V x D (mm)	Pak.	Šifra
5	1	60	300 x 800 x 161	1	<b>FWB51D1</b>
	2	120	550 x 800 x 161	1	<b>FWB52D1</b>
	3	180	800 x 800 x 161	1	<b>FWB53D1</b>
	4	240	1050 x 800 x 161	1	<b>FWB54D1</b>



FWB53D1

### univers N/Ž razvodni ormar, prazan bez vrata IP30, visine 950 mm

Redova	Polja	Modula	Dimenzije Š x V x D (mm)	Pak.	Šifra
6	1	72	300 x 950 x 161	1	<b>FWB61D1</b>
	2	144	550 x 950 x 161	1	<b>FWB62D1</b>
	3	216	800 x 950 x 161	1	<b>FWB63D1</b>
	4	288	1050 x 950 x 161	1	<b>FWB64D1</b>



FWB61D

### univers N/Ž razvodni ormar, prazan bez vrata IP30, visine 1100 mm

Redova	Polja	Modula	Dimenzije Š x V x D (mm)	Pak.	Šifra
7	1	84	300 x 1100 x 161	1	<b>FWB71D1</b>
	2	168	550 x 1100 x 161	1	<b>FWB72D1</b>
	3	252	800 x 1100 x 161	1	<b>FWB73D1</b>
	4	336	1050 x 1100 x 161	1	<b>FWB74D1</b>



FWB71S

### univers N/Ž razvodni ormar, prazan bez vrata IP30, visine 1250 mm

Redova	Polja	Modula	Dimenzije Š x V x D (mm)	Pak.	Šifra
8	1	96	300 x 1250 x 161	1	<b>FWB81D1</b>



FWU81D

### univers P/Ž, prazan sa vratima

Redova	Polja	Modula	Dimenzije Š x V x D (mm)	Pak.	Šifra
3	1	36■	300 x 500 x 110	1	★ FWU31D
	2	72■	550 x 500 x 110	1	★ FWU32D
	3	108■	800 x 500 x 110	1	★ FWU33D
4	1	48■	300 x 650 x 110	1	★ FWU41D
	2	96■	550 x 650 x 110	1	★ FWU42D
	3	144■	800 x 650 x 110	1	★ FWU43D
5	1	60■	300 x 800 x 110	1	★ FWU51D
	2	120■	550 x 800 x 110	1	★ FWU52D
	3	180■	800 x 800 x 110	1	★ FWU53D
6	1	72■	300 x 950 x 110	1	★ FWU61D
	2	144■	550 x 950 x 110	1	★ FWU62D
	3	216■	800 x 950 x 110	1	★ FWU63D
7	1	84■	300 x 1100 x 110	1	★ FWU71D
	2	168■	550 x 1100 x 110	1	★ FWU72D
	3	252■	800 x 1100 x 110	1	★ FWU73D
8	1	96■	300 x 1250 x 110	1	★ FWU81D



FWU71L

### Osnova/kučičšte univers ormara - ugradni element

Redova	Polja	Modula	Dimenzije Š x V x D (mm)	Pak.	Šifra
3	1	36■	300 x 500 x 110	1	★ FWU31L
	2	72■	550 x 500 x 110	1	★ FWU32L
	3	108■	800 x 500 x 110	1	★ FWU33L
4	1	48■	300 x 650 x 110	1	★ FWU41L
	2	96■	550 x 650 x 110	1	★ FWU42L
	3	144■	800 x 650 x 110	1	★ FWU43L
5	1	60■	300 x 800 x 110	1	★ FWU51L
	2	120■	550 x 800 x 110	1	★ FWU52L
	3	180■	800 x 800 x 110	1	★ FWU53L
6	1	72■	300 x 950 x 110	1	★ FWU61L
	2	144■	550 x 950 x 110	1	★ FWU62L
	3	216■	800 x 950 x 110	1	★ FWU63L
7	1	84■	300 x 1100 x 110	1	★ FWU71L
	2	168■	550 x 1100 x 110	1	★ FWU72L
	3	252■	800 x 1100 x 110	1	★ FWU73L
8	1	96■	300 x 1250 x 110	1	★ FWU81L

## Ugradbeni set za N/Ž razvodne ormare

Polja	Dimenzije Š x V x D (mm)	Pak.	Šifra
3	250 x 450 x 87	1	<b>UW31V</b>
4	250 x 600 x 87	1	<b>UW41V</b>
5	250 x 750 x 87	1	<b>UW51V</b>
6	250 x 900 x 87	1	<b>UW61V</b>
7	250 x 1050 x 87	1	<b>UW71V</b>
8	250 x 1200 x 87	1	<b>UW81V</b>



UW31V

## DIN šina, izolirano ugrađena, upuštena za N/Ž razvodne ormare

Opis	Pak.	Šifra
DIN šina, univers, 1 polje, 7,5 mm	1	<b>UT22B</b>
DIN šina, univers, 1 polje, 7,5 mm, izolirana	1	<b>UT22C</b>



UT22B

## Bravica za vrata sa 2 ključa za nadogradnju

Opis	Pak.	Šifra
Brava, univers, cilindar No. 1242E	1	<b>FZ597N</b>



FZ597N

## Spojni setovi za 2 N/Ž ormara - jedan na drugi

Opis	Polja	Pak.	Šifra
Spojni set, vertikalni za ormare: - IP30 / IP44 / IP54 jedan na drugi	1	1	<b>FZ441B</b>
- IP30 / IP44 / IP54 ormare na postolju	2	1	<b>FZ442B</b>
	3	1	<b>FZ443B</b>
	4	1	<b>FZ444B</b>
	5	1	<b>FZ445B</b>



FZ441B

## Uvodnice za kablove sa poledine, za N/Ž ormare

Opis	Pak.	Šifra
Uvodnica za uvođenje kablova sa poledine, za ormare univers IP44 / IP54 (za područje koje se blombira)	1	<b>FZ428</b>



FZ428

## Uvodnice za sa donje i gornje strane, za N/Ž ormare

Opis	Pak.	Šifra
Uvodnica za uvođenje kablova sa donje i gornje strane: - za perforirana mjesta na gornjem i donjem dijelu ormara - za područje koje se blombira	1	<b>FZ425</b>



FZ425



FZ010NV1

Razvodni ormari

### Perforirana desna vrata za kućište/osnovu P/Ž ormara ili kao zamjenska

Opis	za ormare Š x V (mm)	Pak.	Šifra
Perforirana desna vrata za kućište osnovu P/Ž univers ormara	300 x 500	1	<b>FZ001NV1</b>
- sa FZ598N	550 x 500	1	<b>FZ002NV1</b>
- perforirana za bolje hlađenje ormara	300 x 650	1	<b>FZ005NV1</b>
	550 x 650	1	<b>FZ006NV1</b>
	300 x 800	1	<b>FZ009NV1</b>
	550 x 800	1	<b>FZ010NV1</b>
	300 x 950	1	<b>FZ013NV1</b>
	550 x 950	1	<b>FZ014NV1</b>
	300 x 1100	1	<b>FZ021NV1</b>
	550 x 1100	1	<b>FZ022NV1</b>
	300 x 1250	1	<b>FZ026NV1</b>



FZ006NM

### Multimedijalna perforirana desna vrata za kućište/osnovu P/Ž ormara ili kao zamjenska

Opis	za ormare Š x V (mm)	Pak.	Šifra
Multimedijalna perforirana desna vrata sa bravom i PVC umetkom za kućište osnovu P/Ž univers ormara	550 x 500	1	★ <b>FZ002NM</b>
- sa FZ598N	300 x 650	1	★ <b>FZ005NM</b>
- PVC materijal za poboljšani WLAN prijem. Testirano po GHMT principu	550 x 650	1	★ <b>FZ006NM</b>
	800 x 650	1	★ <b>FZ007NM</b>
	300 x 800	1	★ <b>FZ009NM</b>
	550 x 800	1	★ <b>FZ010NM</b>
	800 x 800	1	★ <b>FZ011NM</b>
	300 x 950	1	★ <b>FZ013NM</b>
	550 x 950	1	★ <b>FZ014NM</b>
	300 x 1100	1	★ <b>FZ021NM</b>
	550 x 1100	1	★ <b>FZ022NM</b>
	300 x 1250	1	★ <b>FZ026NM</b>



FZ010NM2

### Multimedijalna perforirana desna vrata za kućište/osnovu P/Ž ormara ili kao zamjenska

Opis	za ormare Š x V (mm)	Pak.	Šifra
Multimedijalna puna desna vrata sa bravom i PVC umetkom za kućište osnovu P/Ž univers ormara	550 x 500	1	★ <b>FZ002NM2</b>
- sa FZ598N	550 x 650	1	★ <b>FZ006NM2</b>
- PVC materijal za poboljšani WLAN prijem. Testirano po GHMT principu	550 x 800	1	★ <b>FZ010NM2</b>
	550 x 950	1	★ <b>FZ014NM2</b>
	300 x 1100	1	★ <b>FZ021NM2</b>
	550 x 1100	1	★ <b>FZ022NM2</b>
	300 x 1250	1	★ <b>FZ026NM2</b>



UW41U

### DIN konstrukcija sa poklopcem za P/Ž ormare - zaštitna klasa II

Opis	Redova	Visina (mm)	Pak.	Šifra
DIN konstrukcija sa poklopcem: - zaštitna klasa II	3	450	1	<b>UW31U</b>
- razmak između DIN šina 125 mm	4	600	1	<b>UW41U</b>
- QuickConnect stezaljke	5	750	1	<b>UW51U</b>
- UW31U - 2x18	6	900	1	<b>UW61U</b>
- UW41 - 81U - 2x22	7	1050	1	<b>UW71U</b>
	8	1200	1	<b>UW81U</b>

## Pregrada horizontalna, između razdjelnih polja za P/Ž ormare

Opis	Dimenzije Š x V (mm)	Pak.	Šifra
Pregrada, horizontalna, 1 polje (montaža na nosive šine ormara univers)	245 x 45	1	<b>UT44EN</b>
Pregrada, horizontalna (montaža na nosive šine ormara univers)	260 x 90	1	<b>ZZ10H</b>



## Montažne šine - traverze za P/Ž ormare (FWU)

Opis	Dimenzije Š x V (mm)	Pak.	Šifra
Montažne šine - vertikalne 1 polje (1 set 2 komada)	10,5 x 450	1	<b>UN03FN</b>
	10,5 x 600	1	<b>UN04FN</b>
	10,5 x 750	1	<b>UN05FN</b>
	10,5 x 900	1	<b>UN06FN</b>
	10,5 x 1050	1	<b>UN07FN</b>
	10,5 x 1200	1	<b>UN08FN</b>

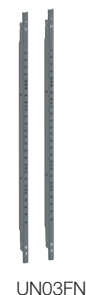

## Montažne šine za N/Ž ormare (FWB)

Opis	Dužina (mm)	Pak.	Šifra
Montažne šine - vertikalne 1 polje (1 set 2 komada)	450	1	<b>UN03A</b>
	600	1	<b>UN04A</b>
	750	1	<b>UN05A</b>
	900	1	<b>UN06A</b>
	1050	1	<b>UN07A</b>
	1200	1	<b>UN08A</b>



## DIN šine

Opis	Dimenzije Š x V x D (mm)	Polja	Pak.	Šifra
DIN šine za pričvršćivanje na nosive šine UNxxA - 35 x 15 x 1,5 mm sa 2 vijka	246 x 15 x 15	1	1	<b>UZ01B4</b>
	496 x 15 x 15	2	1	<b>UZ02B4</b>
	746 x 15 x 15	3	1	<b>UZ03B4</b>
	996 x 15 x 15	4	1	<b>UZ04B4</b>



## Montažna ploča - podesiva po dubini sa nosačima

Opis	Dimenzije Š x V x D (mm)	Pak.	Šifra
Montažna ploča - podesiva po dubini 27 mm	210x 115 x 2,5	1	<b>UT26A</b>
	210x 215 x 2,5	1	<b>UT26B</b>



## Šina za postavljanje N/Ž ormara

Opis	Pak.	Šifra
Šina za postavljanje N/Ž ormara, npr. kod više ormara - sa 4 podloške za kačenje ormara - jednostavno montiranje kompletnih ormara	1	<b>FZ890N</b>





# orion.tech

## Ormari za automatizaciju i upravljanje objektima

### Ormari orion.tech IP65

Razvodni ormari orion.tech zaštite IP65, izrađeni od čeličnog lima, predstavljaju idealna rješenja za smještaj opreme prema industrijskim standardima. Fabrički su opremljeni sa montažnom pločom i dostupni u 19 različitih dimenzija.



## orion.tech

- Gornji i donji poklopci su vijčano pričvršćeni što omogućava laku demontažu po potrebi
- Dostupni u 19 različitih dimenzija
- Dostupne širine 200, 250, 300, 400, 500, 600 i 800 mm

## Karakteristike

- Boja: RAL7035
- Zaštita IP65 i IK10 kada su vrata zatvorena.
- In do 630A
- Ui 690V

### orion.tech IP65, širina 200, 250 i 300 mm

Opis	Dimenzije V x Š x D (mm)	Pak.	Šifra
Orion.tech širine 200 mm	250 x 200 x 160	1	★ FL701L
Orion.tech širine 250 mm	300 x 250 x 160	1	★ FL702L
Orion.tech širine 300 mm	300 x 300 x 160	1	★ FL703L
Orion.tech širine 300 mm	400 x 300 x 160	1	★ FL706L
Orion.tech širine 300 mm	400 x 300 x 200	1	★ F707FL



FL701L

### orion.tech IP65, širina 400 i 500 mm

Opis	Dimenzije V x Š x D (mm)	Pak.	Šifra
Orion.tech širine 400 mm	400 x 400 x 200	1	★ FL708L
Orion.tech širine 400 mm	500 x 400 x 200	1	★ FL713L
Orion.tech širine 400 mm	600 x 400 x 200	1	★ FL714L
Orion.tech širine 400 mm	600 x 400 x 250	1	★ FL715L
Orion.tech širine 500 mm	500 x 500 x 200	1	★ FL712L
Orion.tech širine 500 mm	700 x 500 x 250	1	★ FL721L



FL713L

### orion.tech IP65, širina 600 mm

Opis	Dimenzije V x Š x D (mm)	Pak.	Šifra
Orion.tech širine 600 mm	600 x 600 x 250	1	★ FL716L
Orion.tech širine 600 mm	800 x 600 x 250	1	★ FL723L
Orion.tech širine 600 mm	800 x 600 x 300	1	★ FL729L
Orion.tech širine 600 mm	950 x 600 x 250	1	★ FL725L
Orion.tech širine 600 mm	950 x 600 x 300	1	★ FL726L



FL723L

### orion.tech IP65, širina 800 mm

Opis	Dimenzije V x Š x D (mm)	Pak.	Šifra
Orion.tech širine 800 mm	950 x 800 x 300	1	★ FL728L
Orion.tech širine 800 mm	1250 x 800 x 300	1	★ FL730L
Orion.tech širine 800 mm	1250 x 800 x 400	1	★ FL731L



FL731L

metalni orion plus sa punim vratima



metalni orion plus sa prozirnima vratima

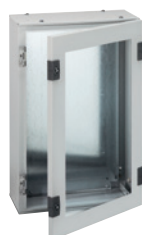

montažna ploča



kostur za modularne uređaje sistem C

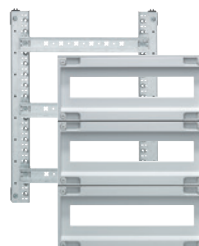

kostur za modularne uređaje sistem S



Razvodni ormari

R.br	Vanjske dimenzije (mm)			Unutrašnja visina	Redova	Sistem C		Sistem S		Metalni ormari sa punim vratima	Metalni ormari sa prozirnima vratima	Montažne ploče	Perforirane montažne ploče	Kosturi za modularne uređaje	
	Visina	Širina	Dubina			Modula po redu	Modula ukupno	Modula po redu	Modula ukupno					Sistem C	Sistem S
1	250	200	160	-	-	-	-	-	-	FL101A	FL151A	FL401A	-	-	-
2	300	250	160	-	-	-	-	-	-	FL102A	FL152A	FL402A	FL472A	-	-
3	300	300	160	-	-	-	-	-	-	FL103A	FL153A	FL403A	-	-	-
4	350	300	160	300	2	10	20	12	24	FL104A	FL154A	FL404A	FL473A	FL990A	FL979A
5	350	300	200	300	2	10	20	12	24	FL105A	FL155A	FL404A	FL473A	FL990A	FL979A
6	400	300	160	-	-	-	-	-	-	FL106A	FL156A	FL405A	-	-	-
7	400	300	200	-	-	-	-	-	-	FL107A	FL157A	FL405A	-	-	-
8	400	400	200	-	-	-	-	-	-	FL108A	FL158A	FL406A	-	-	-
9	500	300	160	450	3	10	30	12	36	FL109A	FL159A	FL407A	FL474A	FL991A	FL981A
10	500	300	200	450	3	10	30	12	36	FL110A	FL160A	FL407A	FL474A	FL991A	FL981A
11	500	400	160	450	3	16	48	18	54	FL111A	FL161A	FL408A	FL475A	FL992A	FL982A
12	500	400	200	450	3	16	48	18	54	FL112A	FL162A	FL408A	FL475A	FL992A	FL982A
13	500	500	200	-	-	-	-	-	-	FL113A	FL163A	FL409A	-	-	-
14	600	400	200	-	-	-	-	-	-	FL114A	FL164A	FL410A	-	-	-
15	600	400	250	-	-	-	-	-	-	FL115A	FL165A	FL410A	-	-	-
16	600	600	250	-	-	-	-	-	-	FL116A	FL166A	FL411A	-	-	-
17	650	400	200	600	4	16	64	18	72	FL117A	FL167A	FL412A	FL476A	FL993A	FL983A
18	650	400	250	600	4	16	64	18	72	FL118A	FL168A	FL412A	FL476A	FL993A	FL983A
19	650	500	200	600	4	22	88	24	96	FL119A	FL169A	FL413A	FL477A	FL994A	FL984A
20	650	500	250	600	4	22	88	24	96	FL120A	FL170A	FL413A	FL477A	FL994A	FL984A
21	800	500	200	750	5	22	110	-	-	FL121A	FL171A	FL414A	FL478A	FL995A	-
22	800	500	250	750	5	22	110	-	-	FL122A	FL172A	FL414A	FL478A	FL995A	-
23	800	600	250	750	5	26	130	28	140	FL123A	FL173A	FL415A	FL479A	FL996A	FL985A
24	800	600	300	750	5	26	130	28	140	FL124A	FL174A	FL415A	FL479A	FL996A	FL985A
25	950	600	250	900	6	26	156	-	-	FL125A	FL175A	FL416A	FL480A	FL997A	-
26	950	600	300	900	6	26	156	-	-	FL126A	FL176A	FL416A	FL480A	FL997A	-
27	950	800	250	900	6	37	222	-	-	FL127A	FL177A	FL417A	FL481A	FL998A	-
28	950	800	300	900	6	37	222	-	-	FL128A	FL178A	FL417A	FL481A	FL998A	-
29	1250	600	250	1200	8	26	208	-	-	FL129A	FL179A	FL418A	FL482A	FL999A	-
30	1250	800	300	1200	8	37	296	-	-	FL130A	FL180A	FL419A	FL483A	FL000A	-

okvir za učinske  
prekidače



slijepi poklopac



montažna ploča



DIN šina



Postolje dubine 150mm	Noseće šine	Otvor za uč.prekidače x160A Visina 300mm	Otvor za uč.prekidače x250A Visina 200mm	Modularni otvori		Montažne ploče				Slijepi poklopci				DIN šine	
				Visina 150mm	Visina 200mm	Visina 150mm	Visina 200mm	Visina 300mm	Visina 400mm	Visina 50mm	Visina 150mm	Visina 200mm	Visina 300mm		
-	-	-	-	-	-	-	-	-	-	-	-	-	-	-	-
-	-	-	-	-	-	-	-	-	-	-	-	-	-	-	-
-	-	-	-	-	-	-	-	-	-	-	-	-	-	-	-
-	-	-	-	-	-	-	-	-	-	-	FL711E	-	-	-	-
-	-	-	-	-	-	-	-	-	-	-	FL711E	-	-	-	-
-	-	-	-	-	-	-	-	-	-	-	-	-	-	-	-
-	-	-	-	-	-	-	-	-	-	-	-	-	-	-	-
-	-	-	-	-	-	-	-	-	-	-	FL711E	-	-	-	-
-	-	-	-	-	-	-	-	-	-	-	FL711E	-	-	-	-
-	FL462A	FL371A	-	FL362A	FL366A	-	-	-	-	FL702E	FL712E	FL722E	-	FL500A	-
-	FL462A	FL371A	-	FL362A	FL366A	-	-	-	-	FL702E	FL712E	FL722E	-	FL500A	-
FL957A	-	-	-	-	-	-	-	-	-	-	-	-	-	-	-
-	-	-	-	-	-	-	-	-	-	-	-	-	-	-	-
-	-	-	-	-	-	-	-	-	-	-	-	-	-	-	-
FL959A	-	-	-	-	-	-	-	-	-	-	-	-	-	-	-
-	FL463A	FL371A	-	FL362A	FL366A	-	-	-	-	FL702E	FL712E	FL722E	-	FL500A	-
-	FL463A	FL371A	-	FL362A	FL366A	FL314A	FL324A	-	-	FL702E	FL712E	FL722E	-	FL500A	-
FL957A	FL463A	FL372A	-	FL363A	FL367A	-	-	-	-	FL703E	FL713E	FL723E	FL733E	FL501A	-
FL958A	FL463A	FL372A	-	FL363A	FL367A	FL315A	FL325A	FL335A	FL345A	FL703E	FL713E	FL723E	FL733E	FL501A	-
FL957A	FL465A	FL372A	-	FL363A	FL367A	-	-	-	-	FL703E	FL713E	FL723E	FL733E	FL501A	-
FL958A	FL465A	FL372A	-	FL363A	FL367A	FL315A	FL325A	FL335A	FL345A	FL703E	FL713E	FL723E	FL733E	FL501A	-
FL959A	FL466A	FL373A	FL380AH	FL364A	FL368A	FL316A	FL326A	FL336A	FL346A	FL704E	FL714E	FL724E	FL734E	FL502A	-
FL960A	FL466A	FL373A	FL380AH	FL364A	FL368A	FL316A	FL326A	FL336A	FL346A	FL704E	FL714E	FL724E	FL734E	FL502A	-
FL959A	FL467A	FL373A	FL380AH	FL364A	FL368A	FL316A	FL326A	FL336A	FL346A	FL704E	FL714E	FL724E	FL734E	FL502A	-
FL960A	FL467A	FL373A	FL380AH	FL364A	FL368A	FL316A	FL326A	FL336A	FL346A	FL704E	FL714E	FL724E	FL734E	FL502A	-
FL961A	FL467A	FL374A	FL381AH	FL365A	FL369A	FL317A	FL327A	FL337A	FL347A	FL705E	FL715E	FL725E	FL735E	FL503A	-
FL962A	FL467A	FL374A	FL381AH	FL365A	FL369A	FL317A	FL327A	FL337A	FL347A	FL705E	FL715E	FL725E	FL735E	FL503A	-
FL959A	FL468A	FL373A	FL380AH	FL364A	FL368A	FL316A	FL326A	FL336A	FL346A	FL704E	FL714E	FL724E	FL734E	FL502A	-
FL962A	FL468A	FL374A	FL381AH	FL365A	FL369A	FL317A	FL327A	FL337A	FL347A	FL705E	FL715E	FL725E	FL735E	FL503A	-

poliester orion plus  
sa punim vratima



poliester orion  
plus sa prozirnim  
vratima



montažne ploče



perforirane  
montažne ploče

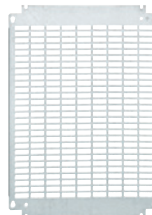

kostur za modularne  
uređaje sistem C

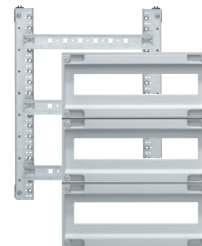

Razvodni ormari

R.br	Vanjske dimenzije (mm)			Unutrašnja visina mm	Redova	Sistem S		Sistem C		Poliester ormari sa punim vratima	Poliester ormari sa prozirnim vratima	Montažne ploče	Perforirane montažne ploče
	Visina	Širina	Dubina			Modula po redu	Modula ukupno	Modula po redu	Modula ukupno				
1	350	300	160	300	2	12	24	10	20	<b>FL204B</b>	<b>FL254B</b>	<b>FL404A</b>	<b>FL473A</b>
2	500	300	200	450	3	12	36	10	30	<b>FL209B</b>	<b>FL259B</b>	<b>FL407A</b>	<b>FL474A</b>
3	500	400	200	450	3	18	54	16	48	<b>FL213B</b>	<b>FL263B</b>	<b>FL408A</b>	<b>FL475A</b>
4	650	400	200	600	4	18	72	16	64	<b>FL216B</b>	<b>FL266B</b>	<b>FL412A</b>	<b>FL476A</b>
5	650	500	250	600	4	24	96	22	88	<b>FL221B</b>	<b>FL271B</b>	<b>FL413A</b>	<b>FL477A</b>
6	800	600	300	750	5	28	140	26	130	<b>FL229B</b>	<b>FL279B</b>	<b>FL415A</b>	<b>FL479A</b>

**kostur za modularne uređaje sistem S**



**montažna ploča**



**slijepi poklopac**



**DIN šina**



Kosturi za modularne uređaje		Noseće šine	Otvor za uč.prekidače 16 - 160A Visina 300mm	Otvor za uč.prekidače 16 - 250A Visina 200mm	Modularni otvori		Montažne ploče				Slijepi poklopci				DIN šine
Sistem C	Sistem S				Visina 150mm	Visina 200mm	Visina 150mm	Visina 200mm	Visina 300mm	Visina 400mm	Visina 50mm	Visina 150mm	Visina 200mm	Visina 300mm	
<b>FL990C</b>	<b>FL980A</b>	-	-	-	-	-	-	-	-	-	-	<b>FL711E</b>	-	-	-
<b>FL991A</b>	<b>FL981A</b>	-	-	-	-	-	-	-	-	-	-	<b>FL711E</b>	-	-	-
<b>FL992A</b>	<b>FL982A</b>	<b>FL462A</b>	<b>FL371A</b>	-	<b>FL362A</b>	<b>FL366A</b>	-	-	-	-	<b>FL702E</b>	<b>FL712E</b>	<b>FL722E</b>	-	<b>FL500A</b>
<b>FL993A</b>	<b>FL983A</b>	<b>FL463A</b>	<b>FL371A</b>	-	<b>FL362A</b>	<b>FL366A</b>	-	-	-	-	<b>FL702E</b>	<b>FL712E</b>	<b>FL722E</b>	-	<b>FL500A</b>
<b>FL994A</b>	<b>FL984A</b>	<b>FL463A</b>	<b>FL372A</b>	-	<b>FL363A</b>	<b>FL367A</b>	<b>FL315A</b>	<b>FL325A</b>	<b>FL335A</b>	<b>FL345A</b>	<b>FL703E</b>	<b>FL713E</b>	<b>FL723E</b>	<b>FL733E</b>	<b>FL501A</b>
<b>FL996A</b>	<b>FL985A</b>	<b>FL466A</b>	<b>FL373A</b>	<b>FL380AH</b>	<b>FL364A</b>	<b>FL368A</b>	<b>FL316A</b>	<b>FL326A</b>	<b>FL336A</b>	<b>FL346A</b>	<b>FL704E</b>	<b>FL714E</b>	<b>FL724E</b>	<b>FL734E</b>	<b>FL502A</b>

**samostojeći poliester orion plus sa punim vratima**



**zidni poliester orion plus sa prozirnim vratima**



**dvodijelni poliester orion plus sa punim vratima**



Razvodni ormari

R.br	Vanjske dimenzije (mm)			Poliester ormari sa punim vratima	Poliester ormari sa prozirnim vratima	Unutrašnja širina mm	Gornji dio visina mm	Donji dio visina mm	Gornji dio			
	Visina	Širina	Dubina						Redova	Modula po redu	Modula ukupno	
zidni ormari	1	550	600	300	FL300B	FL500B	500	450	-	3	23	69
	2	850	600	300	FL301B	FL501B	500	750	-	5	23	115
	3	1150	600	300	FL302B	FL502B	500	1050	-	7	23	161
	4	550	850	300	FL305B	FL505B	750	450	-	3	37	111
	5	850	850	300	FL306B	FL506B	750	750	-	5	37	185
	6	1150	850	300	FL307B	FL507B	750	1050	-	7	37	259
	7	550	1100	300	FL310B	FL510B	500+500	450	-	3	23+23	138
	8	850	1100	300	FL311B	FL511B	500+500	750	-	5	23+23	230
	9	1150	1100	300	FL312B	FL512B	500+500	1050	-	7	23+23	322
samostojeći ormari	10	600	600	300	FL320B	FL520B	500	450	-	3	23	69
	11	900	600	300	FL321B	FL521B	500	750	-	5	23	115
	12	1200	600	300	FL322B	FL522B	500	1050	-	7	23	161
	13	600	850	300	FL325B	FL525B	750	450	-	3	37	111
	14	900	850	300	FL326B	FL526B	750	750	-	5	37	185
	15	1200	850	300	FL327B	FL527B	750	1050	-	7	37	259
	16	600	1100	300	FL330B	FL530B	500+500	450	-	3	23+23	138
	17	900	1100	300	FL331B	FL531B	500+500	750	-	5	23+23	230
	18	1200	1100	300	FL332B	FL532B	500+500	1050	-	7	23+23	322
dvodijelni samostojeći ormari	19	1150	600	300	FL340B	-	500	450	450	3	23	69
	20	1450	600	300	FL342B	-	500	450	750	3	23	69
	21	1750	600	300	FL344B	-	500	450	1050	3	23	69
	22	1750	600	300	FL346B	-	500	750	750	5	23	115
	23	2050	600	300	FL348B	-	500	750	1050	5	23	115
	24	1150	850	300	FL350B	-	750	450	450	3	37	111
	25	1450	850	300	FL352B	-	750	450	750	3	37	111
	26	1750	850	300	FL354B	-	750	450	1050	3	37	111
	27	1750	850	300	FL356B	-	750	750	750	5	37	185
	28	2050	850	300	FL358B	-	750	750	1050	5	37	185
	29	1150	1100	300	FL360B	-	500+500	450	450	3	23+23	138
	30	1450	1100	300	FL362B	-	500+500	450	750	3	23+23	138
	31	1750	1100	300	FL364B	-	500+500	450	1050	3	23+23	138
	32	1750	1100	300	FL366B	-	500+500	750	750	5	23+23	230
	33	2050	1100	300	FL368B	-	500+500	750	1050	5	23+23	230

poliester ormari sa punim vratima



montažne ploče



kosturi za modularne uređaje Sistem C

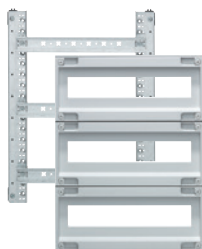

Donji dio			Montažne ploče za za gornji dio	Montažne ploče za donji dio	Kosturi za modularne uređaje za gornji dio (Sistem C)	Kosturi za modularne uređaje za donji dio (Sistem C)	Postolje
Redova	Modula po redu	Modula ukupno					
-	-	-	FL510E	-	FL990B	-	-
-	-	-	FL511E	-	FL992B	-	-
-	-	-	FL512E	-	FL994B	-	-
-	-	-	FL520E	-	FL991B	-	-
-	-	-	FL521E	-	FL993B	-	-
-	-	-	FL522E	-	FL995B	-	-
-	-	-	FL510Ex2-FL530E	-	FL990Bx2	-	-
-	-	-	FL511Ex2-FL531E	-	FL992Bx2	-	-
-	-	-	FL512Ex2-FL532E	-	FL994Bx2	-	-
-	-	-	FL510E	-	FL990B	-	✓
-	-	-	FL511E	-	FL992B	-	✓
-	-	-	FL512E	-	FL994B	-	✓
-	-	-	FL520E	-	FL991B	-	✓
-	-	-	FL521E	-	FL993B	-	✓
-	-	-	FL522E	-	FL995B	-	✓
-	-	-	FL510Ex2-FL530E	-	FL990Bx2	-	✓
-	-	-	FL511Ex2-FL531E	-	FL992Bx2	-	✓
-	-	-	FL512Ex2-FL532E	-	FL994Bx2	-	✓
3	23	69	FL510E	FL510E	FL990B	FL990B	✓
5	23	115	FL510E	FL511E	FL990B	FL992B	✓
7	23	161	FL510E	FL512E	FL990B	FL994B	✓
5	23	115	FL511E	FL511E	FL992B	FL992B	✓
7	23	161	FL511E	FL512E	FL992B	FL994B	✓
3	37	111	FL520E	FL520E	FL991B	FL991B	✓
5	37	185	FL520E	FL521E	FL991B	FL993B	✓
7	37	259	FL520E	FL522E	FL991B	FL995B	✓
5	37	185	FL521E	FL521E	FL993B	FL993B	✓
7	37	259	FL521E	FL522E	FL993B	FL995B	✓
3	23+23	138	FL510Ex2-FL530E	FL510Ex2-FL530E	FL990Bx2	FL990Bx2	✓
5	23+23	230	FL510Ex2-FL530E	FL511Ex2-FL531E	FL990Bx2	FL992Bx2	✓
7	23+23	322	FL510Ex2-FL530E	FL512Ex2-FL532E	FL990Bx2	FL994Bx2	✓
5	23+23	230	FL511Ex2-FL531E	FL511Ex2-FL531E	FL992Bx2	FL992Bx2	✓
7	23+23	322	FL511Ex2-FL531E	FL512Ex2-FL532E	FL992Bx2	FL994Bx2	✓



noseće šine za dodatnu opremu

okvir za učinske prekidače

modularni otvor



Razvodni ormari

R.br	Vanjske dimenzije			Poliester ormari sa punim vratima	Poliester ormari sa prozirnim vratima	Noseće šine za gornji dio	Noseće šine za donji dio	Otvor za učinske prekidače 16-160A Visina 300mm	Otvor za učinske prekidače 16-250A Visina 200mm	Modularni otvori		
	Visina	Širina	Dubina							Visina 150mm	Visina 200mm	
zidni ormari	1	550	600	300	FL300B	FL500B	FL460A	-	-	FL763E	-	
	2	850	600	300	FL301B	FL501B	FL466A	-	-	FL763E	-	
	3	1150	600	300	FL302B	FL502B	FL434A	-	-	FL763E	-	
	4	550	850	300	FL305B	FL505B	FL460A	-	FL374A	FL381AH	FL365A	FL369A
	5	850	850	300	FL306B	FL506B	FL466A	-	FL374A	FL381AH	FL365A	FL369A
	6	1150	850	300	FL307B	FL507B	FL434A	-	FL374A	FL381AH	FL365A	FL369A
	7	550	1100	300	FL310B	FL510B	FL460Ax2	-	-	-	FL763E	-
	8	850	1100	300	FL311B	FL511B	FL466Ax2	-	-	-	FL763E	-
	9	1150	1100	300	FL312B	FL512B	FL434Ax2	-	-	-	FL763E	-
samostojći ormari	10	600	600	300	FL320B	FL520B	FL460A	-	-	-	FL763E	-
	11	900	600	300	FL321B	FL521B	FL466A	-	-	-	FL763E	-
	12	1200	600	300	FL322B	FL522B	FL434A	-	-	-	FL763E	-
	13	600	850	300	FL325B	FL525B	FL460A	-	FL374A	FL381AH	FL365A	FL369A
	14	900	850	300	FL326B	FL526B	FL466A	-	FL374A	FL381AH	FL365A	FL369A
	15	1200	850	300	FL327B	FL527B	FL434A	-	FL374A	FL381AH	FL365A	FL369A
	16	600	1100	300	FL330B	FL530B	FL460Ax2	-	-	-	FL763E	-
	17	900	1100	300	FL331B	FL531B	FL466Ax2	-	-	-	FL763E	-
	18	1200	1100	300	FL332B	FL532B	FL434Ax2	-	-	-	FL763E	-
dvodjelni samostojći ormari	19	1150	600	300	FL340B	-	FL460A	FL460A	-	-	FL763E	-
	20	1450	600	300	FL342B	-	FL460A	FL466A	-	-	FL763E	-
	21	1750	600	300	FL344B	-	FL460A	FL434A	-	-	FL763E	-
	22	1750	600	300	FL346B	-	FL466A	FL466A	-	-	FL763E	-
	23	2050	600	300	FL348B	-	FL466A	FL434A	-	-	FL763E	-
	24	1150	850	300	FL350B	-	FL460A	FL460A	FL374A	FL381AH	FL365A	FL369A
	25	1450	850	300	FL352B	-	FL460A	FL466A	FL374A	FL381AH	FL365A	FL369A
	26	1750	850	300	FL354B	-	FL460A	FL434A	FL374A	FL381AH	FL365A	FL369A
	27	1750	850	300	FL356B	-	FL466A	FL466A	FL374A	FL381AH	FL365A	FL369A
	28	2050	850	300	FL358B	-	FL466A	FL434A	FL374A	FL381AH	FL365A	FL369A
	29	1150	1100	300	FL360B	-	FL460Ax2	FL460Ax2	-	-	FL763E	-
	30	1450	1100	300	FL362B	-	FL460Ax2	FL466Ax2	-	-	FL763E	-
	31	1750	1100	300	FL364B	-	FL460Ax2	FL434Ax2	-	-	FL763E	-
	32	1750	1100	300	FL366B	-	FL466Ax2	FL466Ax2	-	-	FL763E	-
	33	2050	1100	300	FL368B	-	FL466Ax2	FL434Ax2	-	-	FL763E	-

**montažna ploča**

**slijepi poklopac**

**DIN šina**



	Montažne ploče				Slijepi poklopci				DIN šine
	Visina 150mm	Visina 200mm	Visina 300mm	Visina 400mm	Visina 50mm	Visina 150mm	Visina 200mm	Visina 300mm	
FL610E	FL620E	FL630E	FL640E	-	FL710E	-	-	FL500E	
FL610E	FL620E	FL630E	FL640E	-	FL710E	-	-	FL500E	
FL610E	FL620E	FL630E	FL640E	-	FL710E	-	-	FL500E	
FL317A	FL327A	FL337A	FL347A	FL705E	FL715E	FL725E	FL735E	FL503A	
FL317A	FL327A	FL337A	FL347A	FL705E	FL715E	FL725E	FL735E	FL503A	
FL317A	FL327A	FL337A	FL347A	FL705E	FL715E	FL725E	FL735E	FL503A	
FL610E	FL620E	FL630E	FL640E	-	FL710E	-	-	FL500E	
FL610E	FL620E	FL630E	FL640E	-	FL710E	-	-	FL500E	
FL610E	FL620E	FL630E	FL640E	-	FL710E	-	-	FL500E	
FL610E	FL620E	FL630E	FL640E	-	FL710E	-	-	FL500E	
FL610E	FL620E	FL630E	FL640E	-	FL710E	-	-	FL500E	
FL610E	FL620E	FL630E	FL640E	-	FL710E	-	-	FL500E	
FL610E	FL620E	FL630E	FL640E	-	FL710E	-	-	FL500E	
FL610E	FL620E	FL630E	FL640E	-	FL710E	-	-	FL500E	
FL610E	FL620E	FL630E	FL640E	-	FL710E	-	-	FL500E	
FL610E	FL620E	FL630E	FL640E	-	FL710E	-	-	FL500E	
FL610E	FL620E	FL630E	FL640E	-	FL710E	-	-	FL500E	
FL610E	FL620E	FL630E	FL640E	-	FL710E	-	-	FL500E	
FL610E	FL620E	FL630E	FL640E	-	FL710E	-	-	FL500E	
FL610E	FL620E	FL630E	FL640E	-	FL710E	-	-	FL500E	
FL610E	FL620E	FL630E	FL640E	-	FL710E	-	-	FL500E	
FL317A	FL327A	FL337A	FL347A	FL705E	FL715E	FL725E	FL735E	FL503A	
FL317A	FL327A	FL337A	FL347A	FL705E	FL715E	FL725E	FL735E	FL503A	
FL317A	FL327A	FL337A	FL347A	FL705E	FL715E	FL725E	FL735E	FL503A	
FL317A	FL327A	FL337A	FL347A	FL705E	FL715E	FL725E	FL735E	FL503A	
FL317A	FL327A	FL337A	FL347A	FL705E	FL715E	FL725E	FL735E	FL503A	
FL610E	FL620E	FL630E	FL640E	-	FL710E	-	-	FL500E	
FL610E	FL620E	FL630E	FL640E	-	FL710E	-	-	FL500E	
FL610E	FL620E	FL630E	FL640E	-	FL710E	-	-	FL500E	
FL610E	FL620E	FL630E	FL640E	-	FL710E	-	-	FL500E	

### orion plus metalni ormari IP65

- Široka ponuda različitih dimenzija
- Dostupni u izvedbama sa punim i prozirnim vratima
- Gornji i donji poklopac su vijčano pričvršćeni što omogućava laku demontažu po potrebi
- Trokutasta brava

### Karakteristike

- Materijal: čelični lim debljine 12/10
- Materijal vrata: čelik / sigurnosno staklo
- Boja: RAL7035
- Zaštita IP65 sa zatvorenim vratima
- IP30 sa otvorenim vratima
- Zaštita od udaraca IK10 sa zatvorenim vratima
- IK08 sa otvorenim vratima

- Zaštitna klasa I
- Nazivna struja 630A
- Maksimalni radni napon 400V

Standard: IEC 62208



II 3GD ATEX certifikacija za određene modele



FL110A

### orion plus metalni ormari IP65 - puna vrata

Dimenzije Š x V x D (mm)	Broj modula		Pak.	Šifra
	Sistem C	Sistem S		
200 x 250 x 160	-	-	1	FL101A
250 x 300 x 160	-	-	1	FL102A
300 x 300 x 160	-	-	1	FL103A
300 x 350 x 160	20■ (2x10)	24■ (2x12)	1	FL104A
300 x 350 x 200	20■ (2x10)	24■ (2x12)	1	FL105A
300 x 400 x 160	-	-	1	FL106A
300 x 400 x 200	-	-	1	FL107A
400 x 400 x 200	-	-	1	FL108A
300 x 500 x 160	30■ (3x10)	36■ (3x12)	1	FL109A
300 x 500 x 200	30■ (3x10)	36■ (3x12)	1	FL110A
400 x 500 x 160	48■ (3x16)	54■ (3x18)	1	FL111A
400 x 500 x 200	48■ (3x16)	54■ (3x18)	1	FL112A
500 x 500 x 200	-	-	1	FL113A
400 x 600 x 200	-	-	1	FL114A
400 x 600 x 250	-	-	1	FL115A
600 x 600 x 250	-	-	1	FL116A
400 x 650 x 200	64■ (4x16)	72■ (4x18)	1	FL117A
400 x 650 x 250	64■ (4x16)	72■ (4x18)	1	FL118A
500 x 650 x 200	88■ (4x22)	96■ (4x24)	1	FL119A
500 x 650 x 250	88■ (4x22)	96■ (4x24)	1	FL120A
500 x 800 x 200	110■ (5x22)	-	1	FL121A
500 x 800 x 250	110■ (5x22)	-	1	FL122A
600 x 800 x 250	130■ (5x26)	140■ (5x28)	1	FL123A
600 x 800 x 300	130■ (5x26)	140■ (5x28)	1	FL124A
600 x 950 x 250	156■ (6x26)	-	1	FL125A
600 x 950 x 300	156■ (6x26)	-	1	FL126A
800 x 950 x 250	222■ (6x37)	-	1	FL127A
800 x 950 x 300	222■ (6x37)	-	1	FL128A
600 x 1250 x 250	208■ (8x26)	-	1	FL129A
800 x 1250 x 300	296■ (8x37)	-	1	FL130A

**orion plus metalni ormari IP65 - staklena vrata vrata**

Dimenzije Š x V x D (mm)	Broj modula		Pak.	Šifra
	Sistem C	Sistem S		
200 x 250 x 160	-	-	1	<b>FL151A</b>
250 x 300 x 160	-	-	1	<b>FL152A</b>
300 x 300 x 160	-	-	1	<b>FL153A</b>
300 x 350 x 160	20■ (2x10)	24■ (2x12)	1	<b>FL154A</b>
300 x 350 x 200	20■ (2x10)	24■ (2x12)	1	<b>FL155A</b>
300 x 400 x 160	-	-	1	<b>FL156A</b>
300 x 400 x 200	-	-	1	<b>FL157A</b>
400 x 400 x 200	-	-	1	<b>FL158A</b>
300 x 500 x 160	30■ (3x10)	36■ (3x12)	1	<b>FL159A</b>
300 x 500 x 200	30■ (3x10)	36■ (3x12)	1	<b>FL160A</b>
400 x 500 x 160	48■ (3x16)	54■ (3x18)	1	<b>FL161A</b>
400 x 500 x 200	48■ (3x16)	54■ (3x18)	1	<b>FL162A</b>
500 x 500 x 200	-	-	1	<b>FL163A</b>
400 x 600 x 200	-	-	1	<b>FL164A</b>
400 x 600 x 250	-	-	1	<b>FL165A</b>
600 x 600 x 250	-	-	1	<b>FL166A</b>
400 x 650 x 200	64■ (4x16)	72■ (4x18)	1	<b>FL167A</b>
400 x 650 x 250	64■ (4x16)	72■ (4x18)	1	<b>FL168A</b>
500 x 650 x 200	88■ (4x22)	96■ (4x24)	1	<b>FL169A</b>
500 x 650 x 250	88■ (4x22)	96■ (4x24)	1	<b>FL170A</b>
500 x 800 x 200	110■ (5x22)	-	1	<b>FL171A</b>
500 x 800 x 250	110■ (5x22)	-	1	<b>FL172A</b>
600 x 800 x 250	130■ (5x26)	140■ (5x28)	1	<b>FL173A</b>
600 x 800 x 300	130■ (5x26)	140■ (5x28)	1	<b>FL174A</b>
600 x 950 x 250	156■ (6x26)	-	1	<b>FL175A</b>
600 x 950 x 300	156■ (6x26)	-	1	<b>FL176A</b>
800 x 950 x 250	222■ (6x37)	-	1	<b>FL177A</b>
800 x 950 x 300	222■ (6x37)	-	1	<b>FL178A</b>
600 x 1250 x 250	208■ (8x26)	-	1	<b>FL179A</b>
800 x 1250 x 300	296■ (8x37)	-	1	<b>FL180A</b>



FL169A

Razvodni ormari

### orion plus poliester ormari IP66

- Zaštita IP66
- Dostupni u izvedbama sa punim i prozirnim vratima
- Napravljeni od poliestera ojačanog staklenim vlaknima
- Trokutasta brava

### Karakteristike

- Materijal: poliester debljine 3.5mm, ojačan staklenim vlaknima
- Materijal vrata: poliester / sigurnosno staklo
- Boja: RAL7035
- Zaštita IP66 sa zatvorenim vratima
- IP30 sa otvorenim vratima
- Zaštita od udaraca IK10
- Zaštitna klasa II
- Nazivna struja 630A

- Maksimalni radni napon 400V

**Standard:** IEC 62208



Samogasivi materijal na 960°C u skladu sa IEC 60 695-2-10 i IEC 60 695-2-11



II 3GD ATEX certifikacija za određene modele



FL216B

### orion plus poliester ormari IP66 - puna vrata

Dimenzije Š x V x D (mm)	Broj modula		Pak.	Šifra
	Sistem C	Sistem S		
300 x 350 x 160	20■ (2x10)	24■ (2x12)	1	FL204B
300 x 500 x 200	30■ (3x10)	36■ (3x12)	1	FL209B
400 x 500 x 200	48■ (3x16)	54■ (3x18)	1	FL213B
400 x 650 x 200	64■ (4x16)	72■ (4x18)	1	FL216B
500 x 650 x 250	88■ (4x22)	96■ (4x24)	1	FL221B
600 x 800 x 300	130■ (5x26)	140■ (5x28)	1	FL229B



FL266B

### orion plus poliester ormari IP66 - prozirna vrata

Dimenzije Š x V x D (mm)	Broj modula		Pak.	Šifra
	Sistem C	Sistem S		
300 x 350 x 160	20■ (2x10)	24■ (2x12)	1	FL254B
300 x 500 x 200	30■ (3x10)	36■ (3x12)	1	FL259B
400 x 500 x 200	48■ (3x16)	54■ (3x18)	1	FL263B
400 x 650 x 200	64■ (4x16)	72■ (4x18)	1	FL266B
500 x 650 x 250	88■ (4x22)	96■ (4x24)	1	FL271B
600 x 800 x 300	130■ (5x26)	140■ (5x28)	1	FL279B

### orion plus poliester ormari IP65

- Zaštita IP65
- Dostupni u izvedbama sa punim i staklenim vratima
- Trokutasta brava

### Karakteristike

- Materijal: poliester debljine 3.5mm
- Materijal vrata: poliester / sigurnosno staklo
- Boja: RAL7035
- Zaštita IP65 sa zatvorenim vratima  
IP30 sa otvorenim vratima
- Zaštita od udaraca IK10
- Zaštitna klasa II
- Nazivna struja 630A

- Maksimalni radni napon 400V

**Standard:** IEC 62208



Samogasivi materijal na 960°C  
u skladu sa IEC 60 695-2-10  
i IEC 60 695-2-11

### orion plus poliester ormari IP65 - puna vrata

Dimenzije Š x V x D (mm)	Broj modula		Pak.	Šifra
	Sistem C	Sistem S		
600 x 550 x 300	69■ (3x23)	-	1	<b>FL300B</b>
600 x 850 x 300	115■ (5x23)	-	1	<b>FL301B</b>
600 x 1150 x 300	161■ (7x23)	-	1	<b>FL302B</b>
850 x 550 x 300	111■ (3x37)	-	1	<b>FL305B</b>
850 x 850 x 300	185■ (5x37)	-	1	<b>FL306B</b>
850 x 1150 x 300	259■ (7x37)	-	1	<b>FL307B</b>



FL301B

### orion plus poliester ormari IP65 - prozirna vrata

Dimenzije Š x V x D (mm)	Broj modula		Pak.	Šifra
	Sistem C	Sistem S		
600 x 550 x 300	69■ (3x23)	-	1	<b>FL500B</b>
600 x 850 x 300	115■ (5x23)	-	1	<b>FL501B</b>
600 x 1150 x 300	161■ (7x23)	-	1	<b>FL502B</b>
850 x 550 x 300	111■ (3x37)	-	1	<b>FL505B</b>
850 x 850 x 300	185■ (5x37)	-	1	<b>FL506B</b>
850 x 1150 x 300	259■ (7x37)	-	1	<b>FL507B</b>



FL501B

### orion plus poliester ormari IP65 sa 2 kolone - puna vrata

#### Karakteristike:

- Broj modula po redu: 46 Modula (2x23)

Dimenzije Š x V x D (mm)	Broj modula		Pak.	Šifra
	Sistem C	Sistem S		
1100 x 550 x 300	138■ (3x46)	-	1	<b>FL310B</b>
1100 x 850 x 300	230■ (5x46)	-	1	<b>FL311B</b>
1100 x 1150 x 300	322■ (7x46)	-	1	<b>FL312B</b>



FL310B

### orion plus poliester ormari IP65 sa 2 kolone - prozirna vrata

#### Karakteristike:

- Broj modula po redu: 46 Modula (2x23)

Dimenzije Š x V x D (mm)	Broj modula		Pak.	Šifra
	Sistem C	Sistem S		
1100 x 550 x 300	138■ (3x46)	-	1	<b>FL510B</b>
1100 x 850 x 300	230■ (5x46)	-	1	<b>FL511B</b>
1100 x 1150 x 300	322■ (7x46)	-	1	<b>FL512B</b>



FL511B

### orion plus samostojeći poliestere ormari IP65

- Sa dimenzijama do 2050mm visine
- Dostupne 2-dijelne izvedbe (gornji/donji dio)
- Dostupni u izvedbama sa punim i staklenim vratima
- Trokutasta brava

### Karakteristike

- Materijal: poliester debljine 3.5mm
- Materijal vrata: poliester / sigurnosno staklo
- Boja: RAL7035
- Zaštita IP65 sa zatvorenim vratima
- IP30 sa otvorenim vratima
- Zaštitna klasa II
- Nazivna struja 630A

- Maksimalni radni napon 400V

**Standard:** IEC 62208



Samogasivi materijal na 960°C  
u skladu sa IEC EN 60 695-2-1



FL321B

### orion plus samostojeći poliestere ormari IP65 - puna vrata

Dimenzije Š x V x D (mm)	Broj modula		Pak.	Šifra
	Sistem C	Sistem S		
600 x 600 x 300	69■ (3x23)	-	1	<b>FL320B</b>
600 x 900 x 300	115■ (5x23)	-	1	<b>FL321B</b>
600 x 1200 x 300	161■ (7x23)	-	1	<b>FL322B</b>
850 x 600 x 300	111■ (3x37)	-	1	<b>FL325B</b>
850 x 900 x 300	185■ (5x37)	-	1	<b>FL326B</b>
850 x 1200 x 300	259■ (7x37)	-	1	<b>FL327B</b>



FL521B

### orion plus samostojeći poliestere ormari IP65 - staklena vrata

Dimenzije Š x V x D (mm)	Broj modula		Pak.	Šifra
	Sistem C	Sistem S		
600 x 600 x 300	69■ (3x23)	-	1	<b>FL520B</b>
600 x 900 x 300	115■ (5x23)	-	1	<b>FL521B</b>
600 x 1200 x 300	161■ (7x23)	-	1	<b>FL522B</b>
850 x 600 x 300	111■ (3x37)	-	1	<b>FL525B</b>
850 x 900 x 300	185■ (5x37)	-	1	<b>FL526B</b>
850 x 1200 x 300	259■ (7x37)	-	1	<b>FL527B</b>



FL330B

### orion plus samostojeći poliestere ormari IP65 sa 2 kolone - puna vrata

#### Karakteristike:

- Broj modula po redu: 46 Modula (2x23)

Dimenzije Š x V x D (mm)	Broj modula		Pak.	Šifra
	Sistem C	Sistem S		
1100 x 600 x 300	138■ (3x46)	-	1	<b>FL330B</b>
1100 x 900 x 300	230■ (5x46)	-	1	<b>FL331B</b>
1100 x 1200 x 300	322■ (7x46)	-	1	<b>FL332B</b>

### orion plus samostojeći poliestere ormari IP65 sa 2 kolone - staklena vrata

#### Karakteristike:

- Broj modula po redu: 46 Modula (2x23)

Dimenzije Š x V x D (mm)	Broj modula		Pak.	Šifra
	Sistem C	Sistem S		
1100 x 600 x 300	138■ (3x46)	-	1	<b>FL530B</b>
1100 x 900 x 300	230■ (5x46)	-	1	<b>FL531B</b>
1100 x 1200 x 300	322■ (7x46)	-	1	<b>FL532B</b>

### orion plus samostojeći dvodijelni poliester ormari IP65, sa 1 kolonom - puna vrata

Dimenzije Š x V x D (mm)	Visina gornji/ donji dio (mm)	Broj modula		Pak.	Šifra
		Sistem C gornji dio	Sistem C donji dio		
600 x 1150 x 300	550/550	69■ (3x23)	69■ (3x23)	1	<b>FL340B</b>
600 x 1450 x 300	550/850	69■ (3x23)	115■ (5x23)	1	<b>FL342B</b>
600 x 1750 x 300	550/1150	69■ (3x23)	161■ (7x23)	1	<b>FL344B</b>
600 x 1750 x 300	850/850	115■ (5x23)	115■ (5x23)	1	<b>FL346B</b>
600 x 2050 x 300	850/1150	115■ (5x23)	161■ (7x23)	1	<b>FL348B</b>
850 x 1150 x 300	550/550	111■ (3x37)	111■ (3x37)	1	<b>FL350B</b>
850 x 1450 x 300	550/850	111■ (3x37)	185■ (5x37)	1	<b>FL352B</b>
850 x 1750 x 300	550/1150	111■ (3x37)	259■ (7x37)	1	<b>FL354B</b>
850 x 1750 x 300	850/850	185■ (5x37)	185■ (5x37)	1	<b>FL356B</b>
850 x 2050 x 300	850/1150	185■ (5x37)	259■ (7x37)	1	<b>FL358B</b>



FL342B

Razvodni ormari

### orion plus samostojeći dvodijelni poliester ormari IP65, sa 2 kolone - puna vrata

#### Karakteristike:

- Broj modula po redu: 46 Modula (2x23)

Dimenzije Š x V x D (mm)	Visina gornji/ donji dio (mm)	Broj modula		Pak.	Šifra
		Sistem C gornji dio	Sistem C donji dio		
1100 x 1150 x 300	550/550	138■ (3x46)	138■ (3x46)	1	<b>FL360B</b>
1100 x 1450 x 300	550/850	138■ (3x46)	230■ (5x46)	1	<b>FL362B</b>
1100 x 1750 x 300	550/1150	138■ (3x46)	322■ (7x46)	1	<b>FL364B</b>
1100 x 1750 x 300	850/850	230■ (5x46)	230■ (5x46)	1	<b>FL366B</b>
1100 x 2050 x 300	850/1150	230■ (5x46)	322■ (7x46)	1	<b>FL368B</b>



FL362B





FL408A

### Montažne ploče za orion ormare FL1xxA/FL2xxB

za ormare dimenzija Š x V (mm)	Dimenzije montažnih ploča Š x V (mm)	Pak.	Šifra
200 x 250	143 x 230	1	FL401A
250 x 300	193 x 280	1	FL402A
300 x 300	243 x 280	1	FL403A
300 x 350	243 x 330	1	FL404A
300 x 400	243 x 380	1	FL405A
400 x 400	343 x 380	1	FL406A
300 x 500	243 x 480	1	FL407A
400 x 500	343 x 480	1	FL408A
500 x 500	443 x 480	1	FL409A
400 x 600	343 x 580	1	FL410A
600 x 600	543 x 580	1	FL411A
400 x 650	343 x 630	1	FL412A
500 x 650	443 x 630	1	FL413A
500 x 800	443 x 780	1	FL414A
600 x 800	543 x 780	1	FL415A
600 x 950	543 x 930	1	FL416A
800 x 950	743 x 930	1	FL417A
600 x 1250	543 x 1230	1	FL418A
800 x 1250	743 x 1230	1	FL419A



FL510E

### Montažne ploče za orion ormare FL3xxB/FL5xxB

za ormare dimenzija Š x V (mm)	Dimenzije montažnih ploča Š x V (mm)	Pak.	Šifra
600 x 550	493 x 480	1	FL510E
600 x 850	493 x 780	1	FL511E
600 x 1150	493 x 1080	1	FL512E
850 x 550	743 x 480	1	FL520E
850 x 850	743 x 780	1	FL521E
850x1150	743 x 1080	1	FL522E
1100 x 550	993 x 480	1	FL530E
1100 x 850	993 x 780	1	FL531E
1100 x 1150	993 x 1080	1	FL532E

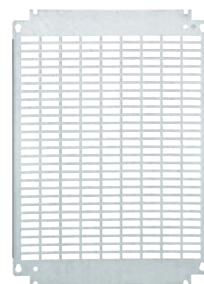

FL475A

### Perforirane montažne ploče za orion ormare FL1xxA/FL2xxB

za ormare dimenzija Š x V (mm)	Dimenzije montažnih ploča Š x V (mm)	Pak.	Šifra
250 x 300	193 x 280	1	FL472A
300 x 350	243 x 330	1	FL473A
300 x 500	243 x 480	1	FL474A
400 x 500	343 x 480	1	FL475A
400 x 650	343 x 630	1	FL476A
500 x 650	443 x 630	1	FL477A
500 x 800	443 x 780	1	FL478A
600 x 800	543 x 780	1	FL479A
600 x 950	543 x 930	1	FL480A
800 x 950	743 x 930	1	FL481A
600 x 1250	543 x 1230	1	FL482A
800 x 1250	743 x 1230	1	FL483A

### Kosturi za modularne uređaje

Kosturi za modularne uređaje dostupni su u dvije vrste za ugradnju uređaja u orion plus razvodne ormare, Sistem S i Sistem C.

#### Sistem C

Kao dodatak razvodnim ormarima, sistem C omogućava prilagođenu ugradnju opreme u ormar (npr. automatski osigurači, glavni prekidači itd) ovisno o potrebama instalacije. Nosači i šine sistema C omogućavaju ugradnju perforiranih kanalicama jer ostavljaju slobodan prostor oko ugrađene opreme. Nakon odabira nosećih šina dodaju se modularni otvori koji će ispuniti zahtjeve instalacije (modularni otvori za učinske prekidače, modularni otvori za automatske osigurače i druge modularne elemente,

DIN šine, slijepo poklopce).

#### Sistem S

Kompletno opremljen kostur koji u potpunosti zauzme

raspoloživi prostor u unutrašnjosti ormara. Namijenjen je isključivo za ugradnju modularnih uređaja (na DIN šinu).

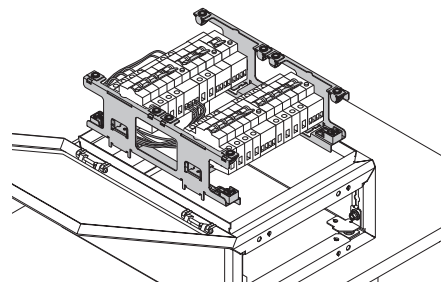
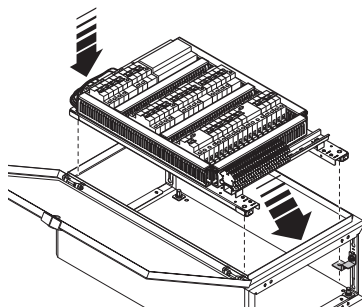

### Sistem S

#### Kosturi za modularne uređaje (za ormare FL1xxA/FL2xxB)

za ormare Š x V (mm)	Redova	Modula po redu	Ukupno modula	Pak.	Šifra
300 x 350*	2	12	24	1	FL979A
300 x 350**	2	12	24	1	FL980A
300 x 500	3	12	36	1	FL981A
400 x 500	3	18	54	1	FL982A
400 x 650	4	18	72	1	FL983A
500 x 650	4	24	96	1	FL984A
600 x 800	5	28	140	1	FL985A

\*samo za FL1xxA

\*\*samo za FL2xxB



FL981A

### Sistem C

#### Kosturi za modularne uređaje (za ormare FL1xxA/FL2xxB)

za ormare Š x V (mm)	Redova	Modula po redu	Ukupno modula	Pak.	Šifra
300 x 350*	2	10	20	1	FL990A
300 x 350**	2	10	20	1	FL990C
300 x 500	3	10	30	1	FL991A
400 x 500	3	16	48	1	FL992A
400 x 650	4	16	64	1	FL993A
500 x 650	4	22	88	1	FL994A
500 x 800	5	22	110	1	FL995A
600 x 800	5	26	130	1	FL996A
600 x 950	6	26	156	1	FL997A
800 x 950	6	37	222	1	FL998A
600 x 1250	8	26	208	1	FL999A
800 x 1250	8	37	296	1	FL000A

\*samo za FL1xxA

\*\*samo za FL2xxB

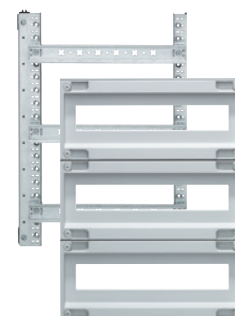

FL992A

#### Kosturi za modularne uređaje (za ormare FL3xxB/FL5xxB)

za ormare Š x V (mm)	Redova	Modula po redu	Ukupno modula	Pak.	Šifra
600 x 550	3	23	69	1	FL990B
850 x 550	3	37	111	1	FL991B
600 x 850	5	23	115	1	FL992B
850 x 850	5	37	185	1	FL993B
600 x 1150	7	23	161	1	FL994B
850 x 1150	7	37	259	1	FL995B



FL372A

### Modularni otvori za učinske prekidače h3

Tip	Montaža	Za ormare širine (mm)	Visina (mm)	Pak.	Šifra
x160	vertikalna	400	300	1	<b>FL371A</b>
		500	300	1	<b>FL372A</b>
		600	300	1	<b>FL373A</b>
		800	300	1	<b>FL374A</b>
x250	horizontalna	600	200	1	<b>FL380AH</b>
		800	200	1	<b>FL381AH</b>



FL363A

### Modularni otvori

Za ormare širine (mm)	Visina (mm)	Modula	Pak.	Šifra
400	150	16■	1	<b>FL362A</b>
500	150	22■	1	<b>FL363A</b>
600	150	26■	1	<b>FL364A</b>
800	150	37■	1	<b>FL365A</b>
400	200	16■	1	<b>FL366A</b>
500	200	22■	1	<b>FL367A</b>
600	200	26■	1	<b>FL368A</b>
800	200	37■	1	<b>FL369A</b>
500	150	23■	1	<b>FL763E</b>



FL501A

### DIN šine

Za ormare širine (mm)	Za kosture za modularne uređaje	Pak.	Šifra
400	FL992A, FL993A	1	<b>FL500A</b>
500	FL994A, FL995A	1	<b>FL501A</b>
600	FL996A, FL997A, FL999A	1	<b>FL502A</b>
800	FL998A, FL000A, FL991A, FL993B, FL995B	1	<b>FL503A</b>
600	FL990B, FL992B, FL994B	1	<b>FL500E</b>

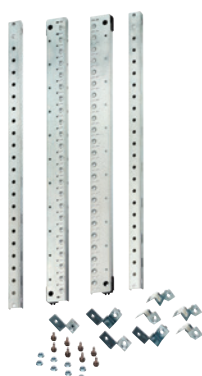

FL466A

### Noseće šine sa elementima za fiksiranje

Za ormare visine (mm)	Visina - vertikalno (mm)	Pak.	Šifra
550	450	1	<b>FL460A</b>
500	450	1	<b>FL462A</b>
650	600	1	<b>FL463A</b>
800, širine 500	750	1	<b>FL465A</b>
800, širine 600	750	1	<b>FL466A</b>
950	900	1	<b>FL467A</b>
1150	1050	1	<b>FL434A</b>
1250	1200	1	<b>FL468A</b>

**Montažne ploče**

Za ormare širine (mm)	Visina (mm)	Pak.	Šifra
400	150	1	<b>FL314A</b>
500	150	1	<b>FL315A</b>
600	150	1	<b>FL316A</b>
800	150	1	<b>FL317A</b>
400	200	1	<b>FL324A</b>
500	200	1	<b>FL325A</b>
600	200	1	<b>FL326A</b>
800	200	1	<b>FL327A</b>
500	300	1	<b>FL335A</b>
600	300	1	<b>FL336A</b>
800	300	1	<b>FL337A</b>
500	400	1	<b>FL345A</b>
600	400	1	<b>FL346A</b>
800	400	1	<b>FL347A</b>
600	150	1	<b>FL610E</b>
600	200	1	<b>FL620E</b>
600	300	1	<b>FL630E</b>
600	400	1	<b>FL640E</b>



FL325A

**Slijepi poklopci**

Za ormare širine (mm)	Visina (mm)	Pak.	Šifra
400	50	1	<b>FL702E</b>
500	50	1	<b>FL703E</b>
600	50	1	<b>FL704E</b>
800	50	1	<b>FL705E</b>
500	150	1	<b>FL710E</b>
300	150	1	<b>FL711E</b>
400	150	1	<b>FL712E</b>
500	150	1	<b>FL713E</b>
600	150	1	<b>FL714E</b>
800	150	1	<b>FL715E</b>
400	200	1	<b>FL722E</b>
500	200	1	<b>FL723E</b>
600	200	1	<b>FL724E</b>
800	200	1	<b>FL725E</b>
500	300	1	<b>FL733E</b>
600	300	1	<b>FL734E</b>
800	300	1	<b>FL735E</b>

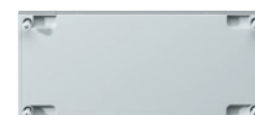

FL712E

**Postolja 150mm za ormare FL1xxA**

Za ormare Š x D (mm)	Pak.	Šifra
500 x 200	1	<b>FL957A</b>
500 x 250	1	<b>FL958A</b>
600 x 250	1	<b>FL959A</b>
600 x 300	1	<b>FL960A</b>
800 x 250	1	<b>FL961A</b>
800 x 300	1	<b>FL962A</b>



FL958A

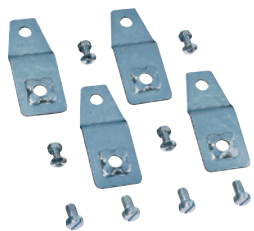

FL85Z

### Pribor za metalne ormare FL1xxA

Opis	Pak.	Šifra
Set za montažu oriona ormara na zid (1 set 4 komada)	1 set	<b>FL85Z</b>
Kabal za uzemljenje	1	<b>FL874A</b>
Set za vertikalno spajanje ormara	1 set	<b>FL670A</b>

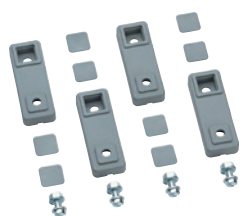

FL863Z

### Pribor za poliester ormare FL2xxB/FL3xxB/FL5xxB

Opis	Pak.	Šifra
Set zidnih nosača za poliester ormare (1 set 4 komada)	1 set	<b>FL863Z</b>
Matice M6 za direktnu montažu uređaja na leđa ormara (1 set 100 komada)	1 set	<b>FZ801</b>
Montažni klizni vodiči za uređaje/montažne ploče (1 set 4 komada)	1 set	<b>FL672E</b>



FL493A

### Nosači klemna za FL1xxA/FL2xxB

Za ormare širine (mm)	Pak.	Šifra
300	1	<b>FL492A</b>
400	1	<b>FL493A</b>
500	1	<b>FL494A</b>
600	1	<b>FL495A</b>
800	1	<b>FL496A</b>



FL96Z

### Brave

Opis	Za ormare	Pak.	Šifra
Trougli umetak 8mm	FL1xxA	1	<b>FL93Z</b>
Dvobradi umetak 3mm	FL1xxA	1	<b>FL95Z</b>
Trougli umetak 8mm	FL2xxB	1	<b>FL94Z</b>
Dvobradi umetak 3mm	FL2xxB	1	<b>FL97Z</b>
Okretna ručica bez brave	FL3xxB/FL5xxB	1	<b>FZ680</b>
Brava sa dva ključa za FZ680	FL3xxB/FL5xxB	1	<b>FL98Z</b>
Ručica sa bravom	FL1xxA/ FL2xxB	1	<b>FL96Z</b>

## Poklopac za zatvaranje modularnog otvora

Opis	Pak.	Šifra
Poklopac za 4■ modula, boja RAL7035 (1 set 4 komada)	1 set	<b>FL871Z</b>



FL871Z

## Kanali i držači kablova

Opis	Pak.	Šifra
Držač kablova (1 set 20 komada)	1 set	<b>UZ25V2</b>
Držač kablova većeg kapaciteta (1 set 20 komada)	1 set	<b>UZ25V1</b>
Adapter za montažu UZ25V1 i UZ25V2 na DIN šinu (1 set 20 komada)	1 set	<b>UZ01V1</b>
Perforirani kanal Š25 x V60, dužina 2m (1 set 2 komada)	1 set	<b>FL70Z</b>
Perforirani kanal Š40 x V60, dužina 2m (1 set 2 komada)	1 set	<b>FL71Z</b>

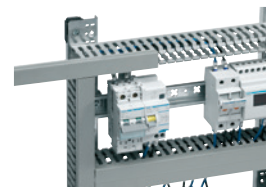

FL70Z

## Traka za natpise

Opis	Pak.	Šifra
Traka za natpise dužine - 24■ modula	1	<b>JE003</b>



JE003

## Jednopolni nosač bakrenih sabirnica 12x5 mm ili mesinganih sabirnica

Opis	Pak.	Šifra
Plastični nosač za Cu sabirnice 12x5mm 160A, ugradnja vertikalna i horizontalna	1	<b>UM01F</b>

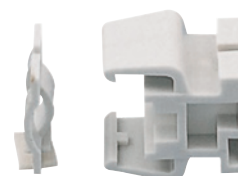

UM01F

## Pribor za montažne ploče

Opis	Pak.	Šifra
Metalni nosači za fiksiranje	1	<b>FL450A</b>
Matica za montiranje sa vijkom M5	1	<b>UC969</b>



FL450A

Ventilatori



FL212Z

Ventilatori IP54 filter sa UV zaštitom

m <sup>3</sup> /h	Snaga (W)	Dimenzije Š x V x D (mm)	Pak.	Šifra
12	10	107 x 107 x 67	1	<b>FL208Z</b>
57	20	150 x 150 x 71	1	<b>FL210Z</b>
115	20	250 x 250 x 113	1	<b>FL212Z</b>
240	29	250 x 250 x 121	1	<b>FL214Z</b>
520	67	325 x 325 x 161	1	<b>FL216Z</b>



FL220Z

Zamjenjive rešetke za ventilatore sa filterom IP54

	Dimenzije Š x V x D (mm)	Pak.	Šifra
za FL208Z	107x 107 x 27	1	<b>FL218Z</b>
za FL210Z	150 x 150 x 28	1	<b>FL220Z</b>
za FL212Z, FL214Z	250 x 250 x 31	1	<b>FL224Z</b>
za FL216Z	325 x 325 x 33	1	<b>FL226Z</b>

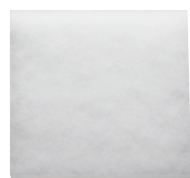

FL958A

Zamjenski filteri IP54

	Pak.	Šifra
za ventilator FL210Z i rešetke FL220Z	1	<b>FL230Z</b>
za ventilatore FL212Z, FL214Z i rešetke FL224Z	1	<b>FL234Z</b>
za ventilator FL216Z i rešetke FL226Z	1	<b>FL236Z</b>



FL240Z

Ventilacijski prorezi IP23

Ventilacijski prorezi	Dimenzije Š x V x D (mm)	Pak.	Šifra
	120 x 120 x 5	1	<b>FL240Z</b>
	160 x 160 x 5	1	<b>FL241Z</b>
	220 x 220 x 5	1	<b>FL242Z</b>



FL253Z

Grijači za ormare IP44

Snaga (W)	Dimenzije D x Š x V (mm)	Pak.	Šifra
15	25 x 70 x 40	1	<b>FL252Z</b>
30	25 x 100 x 47	1	<b>FL253Z</b>
45	61 x 105 x 56	1	<b>FL254Z</b>
80	61 x 155 x 56	1	<b>FL255Z</b>
150	61 x 230 x 56	1	<b>FL256Z</b>



FL258Z



FL259Z

Termostati

Opis	Pak.	Šifra
Termostat, podešavanje od -10 do 80°C, 1k.z., 10A, 230V, 2 modula	1	<b>FL258Z</b>
Termostat, podešavanje od -10 do 80°C, 1k.o., 10A, 230V, 2 modula	1	<b>FL259Z</b>

**Metalni ormari  
orion plus**



# Izdržljivost

## zaštita IP65

orion sa metalnim ili poliester kućištem ojačanim staklenim vlaknima, ormari su za primjenu u nepovoljnim uvjetima i okruženjima gdje su vodonepropusnost i mehanička čvrstoća neophodni.

**Više informacija na [hager.ba](http://hager.ba), [hager.rs](http://hager.rs), [hager.hr](http://hager.hr), [hager-ks.com](http://hager-ks.com) i [hager.al](http://hager.al).**

**:hager**



**Tip čelika AISI304**

- Visoka otpornost na koroziju
- Idealno za upotrebu u prehrambenoj industriji
- Otpornost na prisustvo organskih kiselina
- Jednostavno čišćenje
- Otpornost na djelovanje nitritnog plina kod prisustva vodene pare

**Tip čelika AISI316L**

- Još veći stupanj otpornosti na koroziju zbog prisustva molibdena
- Posebno je pogodan za upotrebu u okruženjima sa hlorisanom ili morskom vodom (npr. bazeni, marine ili obalne instalacije)
- Takođe pogodan za okruženja sa prisustvom korozivnih aditiva i rastvarača (npr. Hemijska industrija)

**Karakteristike**

- Materijal: AISI304 nehrđajući čelik (V2A) i AISI316L (V4A)
- Površina obrađena sa Scotch-Brite 240
- Ugao otvaranja vrata: 120°
- Zaštita: IP66
- Zaštitna klasa I
- Zaštita od udaraca; IK10
- Trokut brava dolazi uz ormar

Razvodni ormar

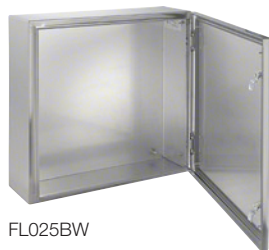

FL025BW

**orion.inox, čelik tip AISI304 - puna vrata**

Dimenzije Š x V x D (mm)	Broj modula Sistem S	Pak.	Šifra
200 x 300 x 150	-	1	<b>FL010BW</b>
300 x 300 x 210	-	1	<b>FL012BW</b>
300 x 400 x 150	-	1	<b>FL014BW</b>
400 x 400 x 210	-	1	<b>FL016BW</b>
400 x 500 x 210	54■	1	<b>FL021BW</b>
500 x 500 x 250	-	1	<b>FL024BW</b>
400 x 600 x 210	-	1	<b>FL025BW</b>
600 x 600 x 250	-	1	<b>FL029BW</b>
500 x 700 x 250	-	1	<b>FL034BW</b>
600 x 800 x 250	140■	1	<b>FL036BW</b>
600 x 800 x 300	140■	1	<b>FL037BW</b>
600 x 1000 x 300	-	1	<b>FL041BW</b>
800 x 1000 x 300	-	1	<b>FL042BW</b>
600 x 1200 x 300	-	1	<b>FL043BW</b>
800 x 1200 x 300	-	1	<b>FL045BW</b>

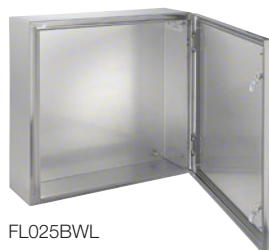

FL025BWL

**orion.inox, čelik tip AISI316L - puna vrata**

Dimenzije Š x V x D (mm)	Broj modula Sistem S	Pak.	Šifra
200 x 300 x 150	-	1	<b>FL010BWL</b>
300 x 300 x 210	-	1	<b>FL012BWL</b>
300 x 400 x 150	-	1	<b>FL014BWL</b>
400 x 400 x 210	-	1	<b>FL016BWL</b>
400 x 500 x 210	54■	1	<b>FL021BWL</b>
500 x 500 x 250	-	1	<b>FL024BWL</b>
400 x 600 x 210	-	1	<b>FL025BWL</b>
600 x 600 x 250	-	1	<b>FL029BWL</b>
500 x 700 x 250	-	1	<b>FL034BWL</b>
600 x 800 x 250	140■	1	<b>FL036BWL</b>
600 x 800 x 300	140■	1	<b>FL037BWL</b>
600 x 1000 x 300	-	1	<b>FL041BWL</b>
800 x 1000 x 300	-	1	<b>FL042BWL</b>
600 x 1200 x 300	-	1	<b>FL043BWL</b>
800 x 1200 x 300	-	1	<b>FL045BWL</b>

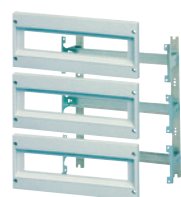

FL982A

**Kosturi za modularne uređaje (Sistem S)**

za ormare dimenzija Š x V (mm)	Redova	Modula po redu	Modula ukupno	Pak.	Šifra
400 x 500	3	18■	54■	1	<b>FL982A</b>
600 x 800	5	28■	140■	1	<b>FL985A</b>

## Montažne ploče (za AISI304 i AISI316L)

za ormare dimenzija Š x V (mm)	dimenzije Š x V (mm)	Pak.	Šifra
200 x 300	134 x 264	1	<b>UZ2030W</b>
300 x 300	234 x 264	1	<b>UZ3030W</b>
300 x 400	234 x 364	1	<b>UZ3040W</b>
400 x 400	334 x 364	1	<b>UZ4040W</b>
400 x 500	334 x 464	1	<b>UZ4050W</b>
500 x 500	334 x 464	1	<b>UZ5050W</b>
400 x 600	334 x 564	1	<b>UZ4060W</b>
600 x 600	534 x 564	1	<b>UZ6060W</b>
500 x 700	434 x 664	1	<b>UZ5070W</b>
600 x 800	534 x 774	1	<b>UZ6080W</b>
600 x 1000	534 x 964	1	<b>UZ60100W</b>
800 x 1000	734 x 964	1	<b>UZ80100W</b>
600 x 1200	534 x 1164	1	<b>UZ60120W</b>
800 x 1200	734 x 1164	1	<b>UZ80120W</b>



UZ3040W

## Zidni nosači

	Pak.	Šifra
Zidni nosači za AISI304 / AISI316L (1 set 4 komada)	1 set	<b>UZ020W</b>



UZ020W

## Brave

	Pak.	Šifra
Brava EK333 sa 2 ključa	1	<b>UZ410LW</b>
Brava sa ručicom L i dva ključa	1	<b>UZ415LW</b>
Brava u obliku slova T sa dva ključa	1	<b>UZ413LW</b>

## Uvodnice IP65

	Pak.	Šifra
M16	20	<b>VZ016M</b>
M20	20	<b>VZ020M</b>
M25	20	<b>VZ025M</b>
M32	20	<b>VZ032M</b>
M40	10	<b>VZ040M</b>
M50	10	<b>VZ050M</b>
M63	10	<b>VZ063M</b>



VZ040M

## Uvodnice IP66 sa ventilacionim sistemom

	Pak.	Šifra
M20	1	<b>VZ020D</b>
M25	1	<b>VZ025D</b>
M32	1	<b>VZ032D</b>





VZ020D

## Čepovi IP66

	Pak.	Šifra
M20 / M25	1	<b>VZ013V</b>
M25 / M32	1	<b>VZ021V</b>



VZ013V

		Zidni ormari dubina 260mm dolaze bez postolja			Samostojeći ormari dubine 260mm i 400mm uključuju postolje od 150mm	
						
Visina ormara (sa gornjim i donjim dijelom, sa ili bez postolja)	Iskoristiva visina - broj modula	Širina ormara: (685mm iskoristiva) 700mm ukupno	Bočne stranice	Postolje	Širina ormara	
					(435mm iskoristiva) 450mm ukupno	(685mm iskoristiva) 700mm ukupno
510mm	450mm - 72■	<b>FM200</b> 72■ (3x24)**	<b>FM400</b>	<b>FM450</b>	-	-
660mm	600mm - 96■	<b>FM201</b> 96■ (4x24)**	<b>FM401</b>	<b>FM450</b>	-	-
810mm	750mm - 120■	<b>FM202</b> 120■ (5x24)**	<b>FM402</b>	<b>FM450</b>	-	-
960mm	900mm - 144■	<b>FM203</b> 144 (6x24) ■**	<b>FM403</b>	<b>FM450</b>	-	-
1110mm	1050mm - 168■	<b>FM204</b> 168■ (7x24)**	<b>FM404</b>	<b>FM450</b>	-	-
1260mm	1200mm - 192■	<b>FM205</b> 192■ (8x24)**	<b>FM405</b>	<b>FM450</b>	-	-
1410mm	1350mm - 216■	<b>FM206</b> 216■ (9x24)**	<b>FM406</b>	<b>FM450</b>	-	-
1710mm	1500mm - 100■/240■/360■	-	-	-	<b>FM107</b> (dub. 260mm) <b>FM117</b> (dub. 400mm) 100■ (10x10)*	<b>FM207</b> (dub. 260mm) <b>FM217</b> (dub. 400mm) <sup>(1)</sup> 240■ (10x24)**
1860mm	1650mm - 110■/264■/396■	-	-	-	<b>FM108</b> (dub. 260mm) <b>FM118</b> (dub. 400mm) 110■ (11x10)*	<b>FM208</b> (dub. 260mm) <b>FM218</b> (dub. 400mm) <sup>(2)</sup> 264■ (11x24)**
2010mm	1800mm - 120■/288■/432■	-	-	-	<b>FM109</b> (dub. 260mm) <b>FM119</b> (dub. 400mm) 120■ (12x10)*	<b>FM209</b> (dub. 260mm) <b>FM219</b> (dub. 400mm) <sup>(3)</sup> 288■ (12x24)**
Set za vertikalnu montažu		<b>FM630 + FN951</b>	-	-	-	-
Set za horizontalnu montažu		<b>FM635 + FN951</b>	-	-	<b>FM635 + FN951</b>	<b>FM635 + FN952</b>

(1) Za sastavljanje ormara i ugradnju elemenata je potrebno postaviti noseće šine FM477

(2) Za sastavljanje ormara i ugradnju elemenata je potrebno postaviti noseće šine FM478

(3) Za sastavljanje ormara i ugradnju elemenata je potrebno postaviti noseće šine FM479

\*Korištenjem konstruktivnog elementa visine 150mm, 10■

\*\*Korištenjem konstruktivnog elementa visine 150mm, 24■

\*\*\*Korištenjem konstruktivnog elementa visine 150mm, 36■

		Noseće šine za kablove / sabirnice		Vrata				
		Bočne stranice	za ormare širine 885mm i dubine 260-400mm	Puna vrata			Prozirna vrata	
(885mm iskoristiva) 900mm ukupno	Širina 435mm			Širina 685mm	Širina 885mm	Širina 685mm	Širina 885mm	
-	-	-	-	-	<b>FM530</b>	-	<b>FM540</b>	-
-	-	-	-	-	<b>FM531</b>	-	<b>FM541</b>	-
-	-	-	-	-	<b>FM532</b>	-	<b>FM542</b>	-
-	-	-	-	-	<b>FM533</b>	-	<b>FM543</b>	-
-	-	-	-	-	<b>FM534</b>	-	<b>FM544</b>	-
-	-	-	-	-	<b>FM535</b>	-	<b>FM545</b>	-
-	-	-	-	-	<b>FM536</b>	-	<b>FM546</b>	-
<b>FM307</b> (dub. 260mm) <b>FM317</b> (dub. 400mm) <sup>(1)</sup> 360■ (10x36)***	<b>FM407</b> (dub. 260mm) <b>FM417</b> (dub. 400mm)	<b>FM427</b> (dub. 260mm) <b>FM437</b> (dub. 400mm)	<b>FM517</b>	<b>FM537</b>	<b>FM557</b>	<b>FM547</b>	<b>FM567</b>	
<b>FM308</b> (dub. 260mm) <b>FM318</b> (dub. 400mm) <sup>(2)</sup> 396■ (11x36)***	<b>FM408</b> (dub. 260mm) <b>FM418</b> (dub. 400mm)	<b>FM428</b> (dub. 260mm) <b>FM438</b> (dub. 400mm)	<b>FM518</b>	<b>FM538</b>	<b>FM558</b>	<b>FM548</b>	<b>FM568</b>	
<b>FM309</b> (dub. 260mm) <b>FM319</b> (dub. 400mm) <sup>(3)</sup> 432■ (12x36)***	<b>FM409</b> (dub. 260mm) <b>FM419</b> (dub. 400mm)	<b>FM429</b> (dub. 260mm) <b>FM439</b> (dub. 400mm)	<b>FM519</b>	<b>FM539</b>	<b>FM559</b>	<b>FM549</b>	<b>FM569</b>	
-	-	-	-	-	-	-	-	-
<b>FM635 + FN953</b>	-	-	-	-	-	-	-	-

### Noseće šine



Y 1710mm	Y 1860mm	Y 2010mm
<b>FM477</b>	<b>FM478</b>	<b>FM479</b>

### Set za povezivanje vertikalno:



**FM630**

### horizontalno:



**FM635**

### Samoljepljiva traka



**FN951**

### Set za transport ormara



**FM653**

### Metalni razvodni ormari IP55

- Robusni metalni okviri velike čvrstoće do 630A
- Mogućnost horizontalnog i vertikalnog spajanja
- razmak između vrata i kostura prednje strane je 54mm

### Karakteristike

- Boja: RAL9010, RAL7042 (postolje)
- Dubine ormara: 260, 400mm
- Visine ormara: 510 do 2010mm
- Širina ormara: 450, 700, 900mm
- Zaštita:
  - IP55 sa vratima
  - IP30 bez vrata
- Otpornost na udarce:
  - IK10 sa vratima
  - IK08 bez vrata

- Nazivna struja:
  - 250A (zidni ormari)
  - 630A (samostojeći ormari)
- Nazivna struja kratkog spoja:
  - 25kA (zidni ormari)
  - 35kA (samostojeći ormari)
- Maksimalni radni napon 690V

**Standard:** IEC EN 62208, IEC EN 61439

► Tehničke informacije na strani 125.



FM203

### Zidni ormari

#### Karakteristike:

- monoblok ormar sa leđnim i gornjim/donjim dijelom

Dubina (mm)	Širina (mm)	Visina (mm)	Modula	Pak.	Šifra
260	700	510	72■ (3x24)	1	<b>FM200</b>
		660	96■ (4x24)	1	<b>FM201</b>
		810	120■ (5x24)	1	<b>FM202</b>
		960	144■ (6x24)	1	<b>FM203</b>
		1110	168■ (7x24)	1	<b>FM204</b>
		1260	192■ (8x24)	1	<b>FM205</b>
		1410	216■ (9x24)	1	<b>FM206</b>



FM208

### Samostojeći ormari sa postoljem

#### Karakteristike:

- monoblok ormar sa leđnim, gornjim/donjim dijelom i postoljem

Dubina (mm)	Širina (mm)	Visina (mm)	Modula	Pak.	Šifra
260	450	1710	100■ (10x10)	1	<b>FM107</b>
		1860	110■ (11x10)	1	<b>FM108</b>
		2010	120■ (12x10)	1	<b>FM109</b>
	700	1710	240■ (10x24)	1	<b>FM207</b>
		1860	264■ (11x24)	1	<b>FM208</b>
		2010	288■ (12x24)	1	<b>FM209</b>
	900	1710	360■ (10x36)	1	<b>FM307</b>
		1860	396■ (11x36)	1	<b>FM308</b>
		2010	432■ (12x36)	1	<b>FM309</b>
400	450	1710	100■ (10x10)	1	<b>FM117</b>
		1860	110■ (11x10)	1	<b>FM118</b>
		2010	120■ (12x10)	1	<b>FM119</b>
	700	1710	240■ (10x24)	1	<b>FM217</b>
		1860	264■ (11x24)	1	<b>FM218</b>
		2010	288■ (12x24)	1	<b>FM219</b>
	900	1710	360■ (10x36)	1	<b>FM317</b>
		1860	396■ (11x36)	1	<b>FM318</b>
		2010	432■ (12x36)	1	<b>FM319</b>

**Bočne stranice**

Za ormare	Visina (mm)	Pak.	Šifra
dubine 260mm	510	1	<b>FM400</b>
	660	1	<b>FM401</b>
	810	1	<b>FM402</b>
	960	1	<b>FM403</b>
	1110	1	<b>FM404</b>
	1260	1	<b>FM405</b>
dubine 260mm	1410	1	<b>FM406</b>
	1710	1	<b>FM407</b>
	1860	1	<b>FM408</b>
dubine 400mm	2010	1	<b>FM409</b>
	1710	1	<b>FM417</b>
	1860	1	<b>FM418</b>
	2010	1	<b>FM419</b>



FM403

Razvodni ormari

**Metalno postolje**

Dimenzije Š x D (mm)	Visina (mm)	Pak.	Šifra
700 x 260	150	1	<b>FM450</b>



FM450

**Noseče šine za kablove / sabirnice**

Dubina ormara (mm)	Za ormare	Pak.	Šifra
260	FM307	1	<b>FM427</b>
	FM308	1	<b>FM428</b>
	FM309	1	<b>FM429</b>
400	FM317	1	<b>FM437</b>
	FM318	1	<b>FM438</b>
	FM319	1	<b>FM439</b>

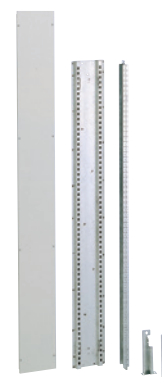

FM428

**Noseče šine za podršku konstruktivnih elemenata**

Dubina ormara (mm)	Za ormare	Pak.	Šifra
400	FM217/FM317	1	<b>FM477</b>
	FM218/FM318	1	<b>FM478</b>
	FM219/FM319	1	<b>FM479</b>

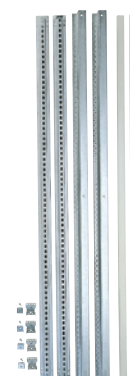

FM479



FM568

### Prozirna vrata

**Karakteristike:**

- razmak između vrata i kostura prednje strane je 54mm.

Za ormare	Visina (mm)	Pak.	Šifra
Za zidne ormare širine 700mm	510	1	<b>FM540</b>
	660	1	<b>FM541</b>
	810	1	<b>FM542</b>
	960	1	<b>FM543</b>
	1110	1	<b>FM544</b>
	1260	1	<b>FM545</b>
	1410	1	<b>FM546</b>
Za samostojeće ormare širine 700mm	1710	1	<b>FM547</b>
	1860	1	<b>FM548</b>
	2010	1	<b>FM549</b>
Za samostojeće ormare širine 900mm	1710	1	<b>FM567</b>
	1860	1	<b>FM568</b>
	2010	1	<b>FM569</b>



FM558

### Puna vrata

**Karakteristike:**

- razmak između vrata i kostura prednje strane je 54mm.

Za ormare	Visina (mm)	Pak.	Šifra
Za zidne ormare širine 700mm	510	1	<b>FM530</b>
	660	1	<b>FM531</b>
	810	1	<b>FM532</b>
	960	1	<b>FM533</b>
	1110	1	<b>FM534</b>
	1260	1	<b>FM535</b>
	1410	1	<b>FM536</b>
Za samostojeće ormare širine 450mm	1710	1	<b>FM517</b>
	1860	1	<b>FM518</b>
	2010	1	<b>FM519</b>
Za samostojeće ormare širine 700mm	1710	1	<b>FM537</b>
	1860	1	<b>FM538</b>
	2010	1	<b>FM539</b>
Za samostojeće ormare širine 900mm	1710	1	<b>FM557</b>
	1860	1	<b>FM558</b>
	2010	1	<b>FM559</b>

**Brave**

Za ormare		Pak.	Šifra
Zidne	Brava sa 2 ključa	1	<b>FZ597</b>
	Trouglasta brava 7mm	1	<b>FZ450</b>
	Dvobrada brava 3mm	1	<b>FZ449</b>
	Brava od plastičnog polikarbonata (trouglasta, četverougaona, dvobrada)	1	<b>FL99Z</b>
Samostojeće	Zakretna ručica	1	<b>FZ680</b>
	Ručka sa okretnom drškom, za prihvat brave promjera 10mm	1	<b>FL78Z</b>
	Brava EK333 sa dva ključa za FZ680, FL78Z	1	<b>FL98Z</b>
	Dvobrada brava 3mm	1	<b>10962</b>
	Brava od plastičnog polikarbonata (trouglasta, četverougaona, dvobrada)	1	<b>FL99Z</b>



FZ597

**Držači dokumenata**

Opis	Pak.	Šifra
Prozirni držač dokumenata, A4, samoljepljivi	1	<b>FZ794</b>
Metalni držač dokumenata, A4, samoljepljivi	1	<b>FZ795D</b>

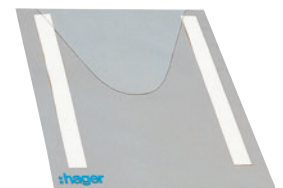

FZ794

**Setovi za spajanje ormara**

Opis	Pak.	Šifra
Set za horizontalno povezivanje dva ormara M6	1	<b>FM635</b>
Set za vertikalno povezivanje dva ormara M12	1	<b>FM630</b>
Samoljepljiva traka 10 x 6mm, dužina 10m	1	<b>FN951</b>



FM630











**Setovi za montažu / transport ormara**

Opis	Pak.	Šifra
Zidni nosači (1 set 4 komada)	1 set	<b>FM640</b>
Set za transport ormara	1	<b>FM653</b>



FM653



Širina	Dubina	Gornji i donji dio	Noseće šine za formiranje okvira	Razdjelnik	Gornji i donji poklopac - puni	Gornji i donji poklopac sa izrezima za uvod kablova	Vrata puna	Vrata prozirna
								
450mm 	600mm	<b>FN020E</b>	<b>FN047E</b>	-	<b>FN080E</b>	<b>FN100E</b>	<b>FN547E</b>	<b>FN511E</b>
	800mm	<b>FN022E</b>			<b>FN082E</b>	<b>FN102E</b>		
700mm 	600mm	<b>FN029E</b>	<b>FN047E</b>	-	<b>FN089E</b>	<b>FN109E</b>	<b>FN507E</b>	<b>FN517E</b>
	800mm	<b>FN013E</b>			<b>FN073E</b>	<b>FN093E</b>		
900mm 	600mm	<b>FN031E</b>	<b>FN047E</b>	-	<b>FN091E</b>	<b>FN111E</b>	<b>FN527E</b>	<b>FN537E</b>
	800mm	<b>FN017E</b>			<b>FN077E</b>	<b>FN097E</b>		
700+200mm 	600mm	<b>FN031E</b>	<b>FN047E</b>	<b>FN287E + FN291E</b>	<b>FN091E</b>	<b>FN111E</b>	<b>FN507E</b>	<b>FN517E</b>
	800mm	<b>FN017E</b>		<b>FN287E + FN292E</b>		<b>FN097E</b>		

Prednja / stražnja puna ploča	Stražnja ploča	Kosturi / okviri za ormare bez vrata	Bočne strane	Postolje 100mm	Unutrašnja vrata	Montažne ploče	Noseće šine 1800mm	Noseće šine 1600mm
								
-	<b>FN217E</b>	-	<b>FN367E</b>	<b>FN440E</b>	-	<b>FN727E</b>	<b>FN697E</b>	<b>FN897E + 2 x FN691E</b>
			<b>FN377E</b>	<b>FN442E</b>				<b>FN897E + 2 x FN692E</b>
-	<b>FN277E</b>	<b>FN407E</b>	<b>FN367E</b>	<b>FN451E</b>	<b>FN701E</b>	<b>FN737E</b>	<b>FN697E</b>	<b>FN897E + 2 x FN691E</b>
			<b>FN377E</b>	<b>FN433E</b>				<b>FN897E + 2 x FN692E</b>
-	<b>FN297E</b>	<b>FN427E</b>	<b>FN367E</b>	<b>FN453E</b>	<b>FN711E</b>	<b>FN747E</b>	<b>FN697E</b>	<b>FN897E + 2 x FN691E</b>
			<b>FN377E</b>	<b>FN437E</b>				<b>FN897E + 2 x FN692E</b>
<b>FN267E</b>	<b>FN297E</b>	<b>FN427E</b>	<b>FN367E</b>	<b>FN453E</b>	<b>FN711E</b>	<b>FN747E</b>	<b>FN697E</b>	<b>FN897E + 2 x FN691E</b>
			<b>FN377E</b>	<b>FN437E</b>				<b>FN897E + 2 x FN692E</b>

Razvodni ormari

Set za bočno spajanje ormara



**FN950**

Samoljepljiva traka



**FN951**

Poklopci



Dubina 600mm  
**FN943E**

Dubina 800mm  
**FN944E**

Metalni nosači za podizanje i transport



**FN760E**

Metalni vijci za podizanje i transport



**FN767**

Set za montažu postolja



**FN430E**

### quadro plus metalni razvodni ormari

- Robusni metalni okviri velike čvrstoće do 4000A
- Sklapanje ormara sa samo 8 vijaka
- Mogućnost horizontalnog spajanja ormara

### Karakteristike

- Materijal: čelik 12-15 / 10
- Boja: RAL9010, RAL7042 (postolje)
- Dubina ormara: 600, 800mm
- Visina ormara: 2100mm

- Širina ormara: 450, 700, 900mm

### - Zaštita:

- P55 sa vratima
- IP30 bez vrata
- Otpornost na udarce:
- IK10 sa vratima
- IK08 bez vrata

- Nazivna struja 4000A

- Nazivna struja kratkog spoja 85kA

- Maksimalni radni napon 690V

**Standard:** IEC EN 62208, IEC EN 61439

► Tehničke informacije na strani 127.



FN029E

### Gornji i donji dio (1 set 2 komada)

za ormare dimenzija Š x D (mm)	Pak.	Šifra
450 x 600	1	<b>FN020E</b>
700 x 600	1	<b>FN029E</b>
900 x 600	1	<b>FN031E</b>
450 x 800	1	<b>FN022E</b>
700 x 800	1	<b>FN013E</b>
900 x 800	1	<b>FN017E</b>



FN089E

### Gornji i donji poklopac - puni

Dimenzije Š x D (mm)	Pak.	Šifra
450 x 600	1	<b>FN080E</b>
700 x 600	1	<b>FN089E</b>
900 x 600	1	<b>FN091E</b>
450 x 800	1	<b>FN082E</b>
700 x 800	1	<b>FN073E</b>
900 x 800	1	<b>FN077E</b>

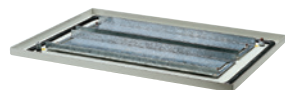

FN109E

### Gornji i donji poklopac sa izrezima za uvod kablova

Dimenzije Š x D (mm)	Pak.	Šifra
450 x 600	1	<b>FN100E</b>
700 x 600	1	<b>FN109E</b>
900 x 600	1	<b>FN111E</b>
450 x 800	1	<b>FN102E</b>
700 x 800	1	<b>FN093E</b>
900 x 800	1	<b>FN097E</b>



FN047E

### Noseće šine za formiranje okvira 2100mm

	Pak.	Šifra
Šine visine 2000mm (1 set 4 komada)	1 set	<b>FN047E</b>



FN292E

### Vertikalni razdjelnik visine 2100mm - dijeli ormar širine 900mm na 700 + 200mm

Dimenzije Š x V x D (mm)	Pak.	Šifra
Vertikalni razdjelnik 2000mm	1	<b>FN287E</b>
Horizontalni razdjelnik za ormare dubine 600mm	1	<b>FN291E</b>
Horizontalni razdjelnik za ormare dubine 800mm	1	<b>FN292E</b>

### Postolja visine 100mm

Dimenzije Š x D (mm)	Pak.	Šifra
450 x 600	1	<b>FN440E</b>
700 x 600	1	<b>FN451E</b>
900 x 600	1	<b>FN453E</b>
450 x 800	1	<b>FN442E</b>
700 x 800	1	<b>FN433E</b>
900 x 800	1	<b>FN437E</b>



FN451E

### Noseće šine 2100mm za konstruktivne elemente

	Visina (mm)	Pak.	Šifra
Puna visina (1 set 4kom)	2000	1 set	<b>FN697E</b>
Parcijalna visina (1 set 4 komada) - za postavljanje sabirničkog sistema na vrhu ormara	1800	1 set	<b>FN897E</b>
Prednji nosači za elemente koji zahtijevaju punu visinu (1 set 2 komada)	2000	1 set	<b>FN697EP</b>
Prednji nosači za elemente koji zahtijevaju parcijalnu visinu (1 set 2 komada) - za postavljanje sabirničkog sistema na na vrhu ormara	1860	1 set	<b>FN897EP</b>

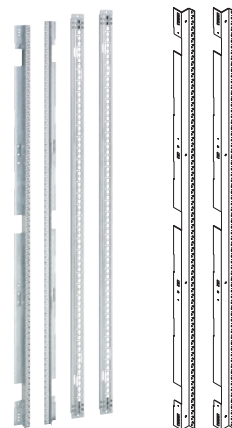

FN697E

FN697EP

### Nosači parcijalne visine (1 set 2 komada)

Visina nosača (mm)	Pak.	Šifra
150	1	<b>FN891E</b>
200	1	<b>FN892E</b>
300	1	<b>FN893E</b>
400	1	<b>FN894E</b>
600	1	<b>FN895E</b>

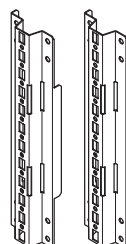

FN892E

### Perforirani bočni nosači

Dimenzije Š x V (mm)	Pak.	Šifra
600 x 50	1	<b>FN691E</b>
800 x 50	1	<b>FN692E</b>



FN691E

### Pirbor nosećih šina koji omogućava ugradnju na obje strane ormara

	Pak.	Šifra
Za ormare širine 700mm	1	<b>UC807</b>
Za ormare širine 900mm	1	<b>UC809</b>

### Konstruktivni element, za modularne uređaje, koji nije potrebno ugraditi na noseće šine

Dimenzije Š x V (mm)	Pak.	Šifra
600 x 200	1	<b>UC206</b>
800 x 200	1	<b>UC208</b>



FN277E

### **Stražnje ploče visine 2100mm**

Za ormare dimenzija Š x V (mm)	Pak.	Šifra
450 x 2100	1	<b>FN217E</b>
700 x 2100	1	<b>FN277E</b>
900 x 2100	1	<b>FN297E</b>

### **Ploča za odvajanje sekcije ormara visine 2100mm**

Dimenzije ormara Š x V (mm)	Pak.	Šifra
200 x 2100	1	<b>FN267E</b>

### **Bočne stranice ormara visine 2100mm**

	Pak.	Šifra
600 x 2100	1	<b>FN367E</b>
800 x 2100	1	<b>FN377E</b>



FN517E

### **Vrata visine 2100mm**

Tip vrata	Dimenzije Š x V (mm)	Pak.	Šifra
Puna vrata	450 x 2100	1	<b>FN547E</b>
	700 x 2100	1	<b>FN507E</b>
	900 x 2100	1	<b>FN527E</b>
Prozirna vrata	450 x 2100	1	<b>FN511E</b>
	700 x 2100	1	<b>FN517E</b>
	900 x 2100	1	<b>FN537E</b>

### **Brave**



FZ680

FL98Z

Opis	Pak.	Šifra
Mehanizam za zadržavanje vrata za ormare širine 700mm i 900mm	1	<b>FN952</b>
Brava sa zakretnom ručicom i ključem	1	<b>FZ508</b>
Dvobradi, trouglasti i četverouglasti ključ	1	<b>FZ850</b>
Zakretna ručica	1	<b>FZ680</b>
Brava od plastičnog polikarbonata (trouglasta, četverougaona, dvobrada)	1	<b>FL99Z</b>
Dvobrada brava 3mm	1	<b>10962</b>

### **Držać dokumenata**



FZ795D

Opis	Pak.	Šifra
Metalni držać dokumenata A4	1	<b>FZ795D</b>

### Pribor za spajanje ormara

	Pak.	Šifra
Set za bočno spajanje ormara (1 set 4 komada)	1 set	<b>FN950</b>
Set za montažu postolja (sa M12 vijcima)	1	<b>FN430E</b>
Samoljepljiva traka 10 x 6mm, dužina 10m	1	<b>FN951</b>
Poklopac 600mm	1	<b>FN943E</b>
Poklopac 800mm	1	<b>FN944E</b>



FN950



FN951

### Pribor za transport ormara

	Pak.	Šifra
Metalni nosači za podizanje ormara, zidni nosači i za transport ormara (1 set 2 komada) - maksimalno opterećenje 500kg / nosaču	1 set	<b>FZ760E</b>
Vijčani (prsten) nosači za podizanje ormara (1 set 4 komada) - pocinčani sa navojem M12 - maksimalno opterećenje 250kg / prsten	1 set	<b>FZ767</b>



FZ760E

FZ767

### Popravka boje ormara

	Pak.	Šifra
Set sprejeva za popravku boje (2x400ml) RAL7042 / RAL9010	1	<b>FC671</b>
Lak 9ml u boji RAL9010 za popravku boje	1	<b>FZ791N</b>



FZ791N

### Završni okviri za ormare bez vrata (IP30)

Dimenzije ormara Š x V (mm)	Pak.	Šifra
700 x 2100	1	<b>FN407E</b>
900 x 2100	1	<b>FN427E</b>



FN407E

### Unutrašnja vrata

Dimenzije ormara Š x V (mm)	Pak.	Šifra
700 x 2100	1	<b>FN701E</b>
900 x 2100	1	<b>FN711E</b>



FN691E

**Višenamjenski metalni nosači - ugradnja na noseće šine 1800mm**

Dužina x širina (mm)	Pak.	Šifra
600 x 50	1	<b>FN691E</b>
800 x 50	1	<b>FN692E</b>



FN877E

**Višenamjenski metalni nosači - ugradnja po širini ormara za dodatnu stabilnost metalnog okvira**

Dužina x širina (mm)	Pak.	Šifra
450 x 50	1	<b>FN875E</b>
700 x 50	1	<b>FN877E</b>
900 x 50	1	<b>FN879E</b>



FN864E

**Višenamjenski metalni nosači - ugradnja po širini ormara na bočne nosače FN691E / FN692E**

Dužina x širina (mm)	Pak.	Šifra
450 x 25	1	<b>FN862E</b>
700 x 25	1	<b>FN864E</b>
900 x 25	1	<b>FN866E</b>
450 x 50	1	<b>FN863E</b>
700 x 50	1	<b>FN865E</b>
900 x 50	1	<b>FN867E</b>



FN884E

**Višenamjenski metalni nosači - za ugradnju na FN86xE nosače**

Dužina x širina (mm)	Pak.	Šifra
600 x 25	1	<b>FN884E</b>
800 x 25	1	<b>FN886E</b>
600 x 50	1	<b>FN885E</b>
800 x 50	1	<b>FN887E</b>



UX807

**Višenamjenski metalni nosači**

Dužina x širina (mm)	Pak.	Šifra
2100 x 25	1	<b>UX807</b>
2100 x 50	1	<b>UX817</b>

## Ventilatori

### Ventilatori IP54 filter sa UV zaštitom

m <sup>3</sup> /h	Snaga (W)	Dimenzije Š x V x D (mm)	Pak.	Šifra
12	10	107 x 107 x 67	1	<b>FL208Z</b>
57	20	150 x 150 x 71	1	<b>FL210Z</b>
115	20	250 x 250 x 113	1	<b>FL212Z</b>
240	29	250 x 250 x 121	1	<b>FL214Z</b>
520	67	325 x 325 x 161	1	<b>FL216Z</b>



FL212Z

### Zamjenjive rešetke za ventilatore sa filterom IP54

	Dimenzije Š x V x D (mm)	Pak.	Šifra
za FL208Z	107x 107 x 27	1	<b>FL218Z</b>
za FL210Z	150 x 150 x 28	1	<b>FL220Z</b>
za FL212Z, FL214Z	250 x 250 x 31	1	<b>FL224Z</b>
za FL216Z	325 x 325 x 33	1	<b>FL226Z</b>



FL220Z

### Zamjenski filteri IP54

	Pak.	Šifra
za ventilator FL210Z i rešetke FL220Z	1	<b>FL230Z</b>
za ventilatore FL212Z, FL214Z i rešetke FL224Z	1	<b>FL234Z</b>
za ventilator FL216Z i rešetke FL226Z	1	<b>FL236Z</b>



FL958A

### Ventilacijski prorezi IP23

	Dimenzije Š x V x D (mm)	Pak.	Šifra
Ventilacijski prorezi	120 x 120 x 5	1	<b>FL240Z</b>
	160 x 160 x 5	1	<b>FL241Z</b>
	220 x 220 x 5	1	<b>FL242Z</b>



F240Z

### Grijači za ormare IP44

Snaga (W)	Dimenzije D x Š x V (mm)	Pak.	Šifra
15	25 x 70 x 40	1	<b>FL252Z</b>
30	25 x 100 x 47	1	<b>FL253Z</b>
45	61 x 105 x 56	1	<b>FL254Z</b>
80	61 x 155 x 56	1	<b>FL255Z</b>
150	61 x 230 x 56	1	<b>FL256Z</b>



FL253Z

### Termostati

Opis	Pak.	Šifra
Termostat, podešavanje od -10 do 80°C, 1k.z., 10A, 230V, 2 modula	1	<b>FL258Z</b>
Termostat, podešavanje od -10 do 80°C, 1k.o., 10A, 230V, 2 modula	1	<b>FL259Z</b>















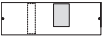

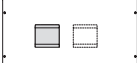

FL258Z



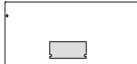

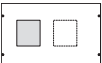
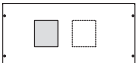







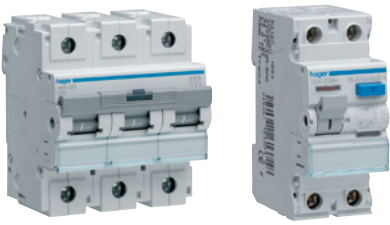























FL259Z



		serija x160			serija x250			serija xh250		
Širina (mm)		350mm	600mm	800mm	350mm	600mm	800mm	350mm	600mm	800mm
Visina (mm)	150mm		 UC013H	 UC014H						
	200mm				 UC127H	 UC128H		 UC127H	 UC128H	
	300mm	 UC010H	 UC011H	 UC012H	 UC020H	 UC021H	 UC022H	 UC020H	 UC021H	 UC022H
	400mm				 UC030H	 UC023H	 UC024H			
	600mm									
	800mm									
	300mm					 UC321HM	 UC322HM			
	400mm									
	600mm									

serija h630			serija h1000 (samo za quadro plus)			serija h1600 (samo za quadro plus)		
								
350mm	600mm	800mm	350mm	600mm	800mm	350mm	600mm	800mm
								
	<b>UC147H</b>	<b>UC148H</b>						
								
<b>UC140H</b>	<b>UC141H</b>	<b>UC142H</b>	<b>UC054H</b>	<b>UC055H</b>				
								
			<b>UC050H</b>	<b>UC051H</b>		<b>UC060H</b>	<b>UC061H</b>	
								
	<b>UC441HM</b>	<b>UC442HM</b>						
								
			<b>UC350HM</b>	<b>UC351HM</b>		<b>UC360HM</b>	<b>UC361HM</b>	

		za rastavne prekidače 160A do 1600A:			za automatske preklopke preklopke HICxxxA		za preklopne sklopke HIB4xxM / HICxxG		
Širina (mm)		350mm	600mm	800mm	600mm	800mm	600mm	800mm	
Visina (mm)	50mm								
	75mm								
	100mm								
	150mm								
	200mm								
	300mm	 UC008	 UC001	 UC002					
		 UC009	 UC003	 UC004	UC311S	UC312S	UC317S (125-400A) UC321S (125-630A)	UC318S (125-400A) UC322S (125-630A)	
	400mm								
	600mm		 UC005 UC270 (quadro plus)	 UC006 UC271 (quadro plus)				UC328S (800-1600A)	
800mm									

za uređaje koji se montiraju na DIN šinu				za mjerne uređaje			slijepi poklopci			perforirane ploče
10 ■	22 ■	24 ■	36 ■							
							 <p>Podesive DIN šine  <b>UC951</b> (500mm)  <b>UC952</b> (750mm)</p> <p>Simetrična DIN šina <b>A099B</b></p>			
350mm	600mm	600mm	800mm	350mm	600mm	800mm	350mm	600mm	800mm	600mm
							 <b>UC221</b>	 <b>UC231</b>	 <b>UC241</b>	
							 <b>UC220</b>	 <b>UC230</b>	 <b>UC240</b>	
								 <b>UC239</b>	 <b>UC249</b>	
 <b>UC200</b>	 <b>UC209</b>	 <b>UC201</b>	 <b>UC203</b>				 <b>UC222</b>	 <b>UC232</b>	 <b>UC242</b>	
		 <b>UC205</b>	 <b>UC207</b>				 <b>UC223</b>	 <b>UC233</b>	 <b>UC243</b>	
				<b>UC213EM</b>	<b>UC233EM</b> <b>UC234EM</b> <b>UC300</b> <b>UC301</b>	<b>UC243EM</b> <b>FN638</b>				
							 <b>UC224</b>	 <b>UC234</b>	 <b>UC244</b>	 <b>UC960</b>
							 <b>UC225</b>	 <b>UC235</b>	 <b>UC245</b>	 <b>UC962</b> (450mm)
							 <b>UC226</b>	 <b>UC236</b>	 <b>UC246</b>	 <b>UC964</b>
							<b>UC227</b>	<b>UC237</b>	<b>UC247</b>	

Konstruktivni elementi za učinske prekidače **h3**

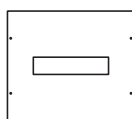

UC010H

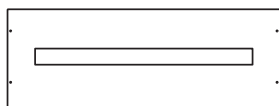

UC012H

**Serija x160**

Tip montaže		Širina (mm)	Visina (mm)	Pak.	Šifra
vertikalna	za 1x4P ili 2x3P učinske prekidače	350	300	1	<b>UC010H</b>
	za 4x4P ili 5x3P učinske prekidače	600	300	1	<b>UC011H</b>
	za 6x4P ili 8x3P učinske prekidače	800	300	1	<b>UC012H</b>
horizontalna	za 1 učinski prekidač 3P ili 4P	600	150	1	<b>UC013H</b>
		800	150	1	<b>UC014H</b>

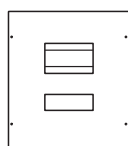

UC030H

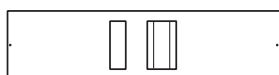

UC128H

**Serija x250 / h250**

Tip montaže		Širina (mm)	Visina (mm)	Pak.	Šifra
vertikalna	za 1 učinski prekidač	350	300	1	<b>UC020H</b>
	za 2 učinska prekidača	600	300	1	<b>UC021H</b>
	za 3 učinska prekidača	800	300	1	<b>UC022H</b>
vertikalna (samo za x250 sa FID blokrom)	za 1 učinski prekidač	350	400	1	<b>UC030H</b>
	za 2 učinska prekidača	600	400	1	<b>UC023H</b>
	za 3 učinska prekidača	800	400	1	<b>UC024H</b>
horizontalna, sa/bez FID blokova	za 1 učinski prekidač	600	200	1	<b>UC127H</b>
		800	200	1	<b>UC128H</b>
vertikalna, za daljinsko upravljanje, klasa II	za 2 učinska prekidača	600	300	1	<b>UC321HM</b>
	za 3 učinska prekidača	800	300	1	<b>UC322HM</b>

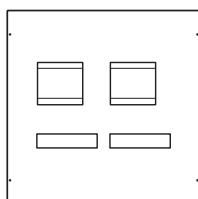

UC145H

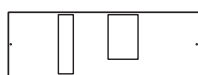

UC147H

**Serija h630**

Tip montaže		Širina (mm)	Visina (mm)	Pak.	Šifra
vertikalna	za 1 učinski prekidač	350	400	1	<b>UC140H</b>
	za 2 učinska prekidača	600	400	1	<b>UC141H</b>
	za 2 učinska prekidača	800	400	1	<b>UC142H</b>
vertikalna (samo za x250)	za 1 učinski prekidač	350	600	1	<b>UC144H</b>
	za 2 učinska prekidača	600	600	1	<b>UC145H</b>
	za 2 učinska prekidača	800	600	1	<b>UC146H</b>
horizontalna, sa/bez FID blokova	za 1 učinski prekidač	600	200	1	<b>UC147H</b>
		800	200	1	<b>UC148H</b>
vertikalna, za daljinsko upravljanje, klasa II	za 1 učinski prekidač	600	400	1	<b>UC441HM</b>
	za 2 učinska prekidača	800	400	1	<b>UC442HM</b>

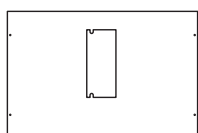

UC054H

**Serija h1000**

Tip montaže		Širina (mm)	Visina (mm)	Pak.	Šifra
vertikalna	za 1 učinski prekidač	600	600	1	<b>UC050H</b>
		800	600	1	<b>UC051H</b>
horizontalna	za 1 učinski prekidač	600	400	1	<b>UC054H</b>
		800	400	1	<b>UC055H</b>
vertikalna, za daljinsko upravljanje, klasa II	za 1 učinski prekidač	600	600	1	<b>UC350HM</b>
		800	600	1	<b>UC351HM</b>

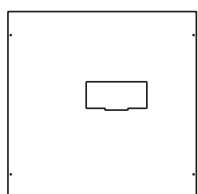

UC360HM

**Serija h1600**

Tip montaže		Širina (mm)	Visina (mm)	Pak.	Šifra
vertikalna	za 1 učinski prekidač	600	600	1	<b>UC060H</b>
		800	600	1	<b>UC061H</b>
vertikalna, za daljinsko upravljanje, klasa II	za 1 učinski prekidač	600	600	1	<b>UC360HM</b>
		800	600	1	<b>UC361HM</b>

### Konstruktivni elementi za rastavne sklopke 125 do 1600A

#### Serija HA 125 do 160A

	Širina (mm)	Visina (mm)	Pak.	Šifra
za 1 rastavnu sklopku	350	300	1	<b>UC008</b>
	600	300	1	<b>UC001</b>
	800	300	1	<b>UC002</b>

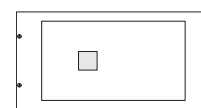

UC001

#### Serija HA 200 do 250A

	Širina (mm)	Visina (mm)	Pak.	Šifra
za 1 rastavnu sklopku	350	300	1	<b>UC009</b>
	600	300	1	<b>UC003</b>
	800	300	1	<b>UC004</b>



UC003

#### Serija HA 400 do 630A

	Širina (mm)	Visina (mm)	Pak.	Šifra
za 1 rastavnu sklopku	600	600	1	<b>UC005</b>
	800	600	1	<b>UC006</b>

#### Serija HA 800 do 1600A (samo za quadro plus)

	Širina (mm)	Visina (mm)	Pak.	Šifra
za 1 rastavnu sklopku	600	600	1	<b>UC270</b>
	800	600	1	<b>UC271</b>

### Konstruktivni elementi za automatske preklopke 63 do 1600A

#### Serija HICxxxA 63 - 160A sa električnim pogonom

	Širina (mm)	Visina (mm)	Pak.	Šifra
za 1 automatsku preklopku	600	300	1	<b>UC311S</b>
	800	300	1	<b>UC312S</b>

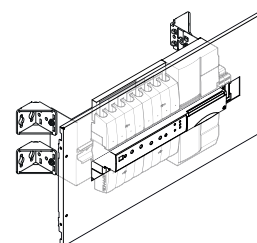

UC311S

#### Serija HIBxxM / HICxxG 125 - 400A sa električnim pogonom

	Širina (mm)	Visina (mm)	Pak.	Šifra
za 1 automatsku preklopku	600	300	1	<b>UC317S</b>
	800	300	1	<b>UC318S</b>

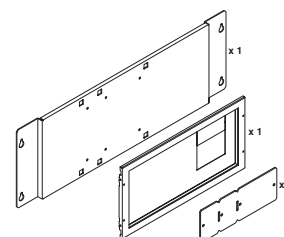

UC317S

#### Serija HIBxxM / HICxxG 125 - 630A sa električnim pogonom (samo za quadro plus)

	Širina (mm)	Visina (mm)	Pak.	Šifra
za 1 rastavnu sklopku	600	300	1	<b>UC321S</b>
	800	300	1	<b>UC322S</b>

#### Serija HIBxxM / HICxxG 800 - 1600A sa električnim pogonom (samo za quadro plus)

	Širina (mm)	Visina (mm)	Pak.	Šifra
za 1 rastavnu sklopku	800	600	1	<b>UC328S</b>

Konstruktivni elementi za modularne uređaje



UC201

Konstruktivni elementi za modularne uređaje

Za ormare širine (mm)	Modula	Širina (mm)	Visina (mm)	Pak.	Šifra
450	10■	350	150	1	<b>UC200</b>
700	24■	600	150	1	<b>UC201</b>
			200	1	<b>UC205</b>
900	36■	800	150	1	<b>UC203</b>
			200	1	<b>UC207</b>

Konstruktivni elementi za modularne uređaje / redne stezaljke

Za ormare širine (mm)	Modula	Širina (mm)	Visina (mm)	Pak.	Šifra
700	21,5■	600	150	1	<b>UC209</b>

Dodatni konstruktivni elementi

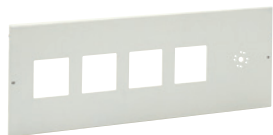

UC301

Konstruktivni elementi za direktnu montažu uređaja

	Širina (mm)	Visina (mm)	Pak.	Šifra
1 uređaj 96x96	350	200	1	<b>UC213EM</b>
3 uređaja 96x96	600	200	1	<b>UC233EM</b>
2 uređaja 96x96 + 3 lampe Ø22	600	200	1	<b>UC234EM</b>
3 uređaja 96x96	800	200	1	<b>UC243EM</b>
2 uređaja 72x72 +2 grebenaste sklopke	600	200	1	<b>UC300</b>
4 uređaja 72x72 +1 grebenasta sklopka	600	200	1	<b>UC301</b>
4 uređaja 72x72 +1 grebenasta sklopka	800	200	1	<b>FN638</b>



UC091

Konstruktivni elementi za LT rastavljače

	Širina (mm)	Visina (mm)	Pak.	Šifra
160A (1xLT052 + 2x16■)	600	300	1	<b>UC090</b>
160A (3xLT052)	600	300	1	<b>UC091</b>
250A (2xLT150)	600	400	1	<b>UC092</b>
400A (2xLT250)	600	400	1	<b>UC093</b>

Dodaci za konstruktivne elemente



UC951

DIN šine

	Dužina (mm)	Modula	Pak.	Šifra
DIN šina, podesiva, nagnuta 20°	500	21,5■	1	<b>UC951</b>
DIN šina, podesiva, nagnuta 20°	750	33,5■	1	<b>UC952</b>
Perforirana DIN šina	2000		1	<b>A099B</b>



HYA036H

Adapter za dizanje DIN šine

	Pak.	Šifra
Adapter za dizanje DIN šine, visina 30mm, 6■ (1 set 3 komada)	1 set	<b>HYA036H</b>



UC268

Baglame

	Pak.	Šifra
Baglame (1 set 2 komada)	1 set	<b>UC268</b>

### Poklopac sa prorezom

#### Karakteristike:

- dimenzije proreza 115 x 405mm
- sa staklom debljine 3mm

Širina (mm)	Visina (mm)	Pak.	Šifra
600	200	1	<b>UC233T</b>



UC233T

### Slijepi poklopci

Širina (mm)	Visina (mm)	Pak.	Šifra
350	50	1	<b>UC221</b>
	75	1	<b>UC220</b>
	150	1	<b>UC222</b>
	200	1	<b>UC223</b>
	300	1	<b>UC224</b>
	400	1	<b>UC225</b>
	600	1	<b>UC226</b>
	800	1	<b>UC227</b>
600	50	1	<b>UC231</b>
	75	1	<b>UC230</b>
	100	1	<b>UC239</b>
	150	1	<b>UC232</b>
	200	1	<b>UC233</b>
	300	1	<b>UC234</b>
	400	1	<b>UC235</b>
	600	1	<b>UC236</b>
800	50	1	<b>UC241</b>
	75	1	<b>UC240</b>
	100	1	<b>UC249</b>
	150	1	<b>UC242</b>
	200	1	<b>UC243</b>
	300	1	<b>UC244</b>
	400	1	<b>UC245</b>
	600	1	<b>UC246</b>
800	1	<b>UC247</b>	



UC221

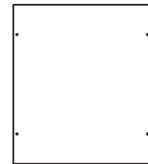

UC225



UC230



UC239



UC232



UC235

### Dodaci za poklopce

#### Baglame

	Pak.	Šifra
Baglame (1 set 2 komada)	1 set	<b>UC268</b>

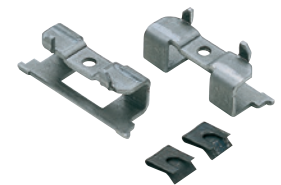

UC268



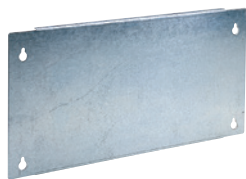

FM484

### Unutrašnje montažne ploče

Širina (mm)	Visina (mm)	Pak.	Šifra
500	150	1	<b>FM482</b>
	200	1	<b>FM483</b>
	300	1	<b>FM484</b>
	450	1	<b>FM485</b>
	600	1	<b>FM486</b>
750	150	1	<b>FM492</b>
	200	1	<b>FM493</b>
	300	1	<b>FM494</b>
	450	1	<b>FM495</b>
	600	1	<b>FM496</b>



FN737E

### Montažne ploče

Za ormare	Širina (mm)	Visina (mm)	Pak.	Šifra
quadro5	500	1500	1	<b>FM487</b>
		1650	1	<b>FM488</b>
		1800	1	<b>FM489</b>
quadro5	750	1500	1	<b>FM497</b>
		1650	1	<b>FM498</b>
		1800	1	<b>FM499</b>
quadro plus	450	2000	1	<b>FN727E</b>
	700	2000	1	<b>FN737E</b>
	900	2000	1	<b>FN747E</b>



UC962

### Perforirane montažne ploče

Širina (mm)	Visina (mm)	Pak.	Šifra
500	300	1	<b>UC960</b>
	450	1	<b>UC962</b>
	600	1	<b>UC964</b>

### Razdjelne horizontalne ploče

Š x V (mm)	Pak.	Šifra
500 x 260	1	<b>UC980</b>
750 x 260	1	<b>UC981</b>





### Pribor za ploče



UC969

### Matica za montiranje

	Pak.	Šifra
Matica za montiranje sa vijkom M5	1	<b>UC969</b>

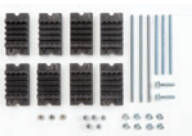
Nosači sabirničkih šina	In	Bakarne šine	Montaža i dodaci (sabirnice, nosači)			
<p>Bočni izgled nosača</p>  <p><b>UC830</b> (str. 110)</p>	do 250A	20 x 5mm	vertikalna ugradnja na postolja			
<p>Raspored sabirnica</p>  <p><b>UC815</b> (str. 110)</p>	do 400A	20 x 5mm 30 x 5mm 32 x 5mm	horizontalna ugradnja 250, 500mm	vertikalna ugradnja 250mm	vertikalna ugradnja na nosače (quadro 5, quadro plus)	
<p>Ravni raspored sabirnica</p>  <p><b>UC820</b> (str. 110)</p>	do 630A	12 x 5mm 20 x 5mm 30 x 5mm 30 x 10mm	horizontalna ugradnja 250, 500mm	vertikalna ugradnja 250mm	vertikalna ugradnja 500, 750mm	vertikalna ugradnja na nosače (quadro plus)
<p>Raspored sabirnica pod uglom</p>  <p><b>UC826</b> (str. 110)</p>	do 630A	20 x 5mm 25 x 5mm 30 x 5mm 30 x 10mm	horizontalna ugradnja 250, 500mm	vertikalna ugradnja 250, 500mm	vertikalna ugradnja na nosače (quadro plus)	
<p>Ravni raspored sabirnica sa fiksnim razmakom između njih</p>  <p><b>UC823 / UC824</b> (str. 111)</p>	do 3200A	50 x 5mm 63x 5mm 80 x 5mm 100 x 5mm 125 x 5mm 50 x 10mm 60x 10mm 80 x 10mm 100 x 10mm 120 x 10mm	horizontalna	vertikalna		
<p>Ravni raspored sa podešivim razmakom između sabirnica (samo quadro plus)</p>  <p><b>UC895E / UC896E / UC897E</b> (str. 111)</p>	do 4000A	50 x 5mm 63x 5mm 80 x 5mm 100 x 5mm 125 x 5mm 50 x 10mm 60x 10mm 80 x 10mm 100 x 10mm 120 x 10mm	horizontalna	vertikalna	bočna	



UC830

**Bočni nosač do 250A za vertikalnu montažu - 25kA**

	Pak.	Šifra
Nosač sabirničkih šina 4P, bočni	1	<b>UC830</b>
Poklopac za sabirničke šine, bočni, 1000mm za UC830	1	<b>UC834</b>



UC815



UC816

**Nosač sabirničkih šina 250 - 400A za vertikalnu i horizontalnu montažu - 12kA**

	Pak.	Šifra
Nosač sabirničkih šina 4P	1	<b>UC815</b>
Poklopac za sabirničke šine 880mm za UC815	1	<b>UC816</b>



UC820

**Nosač sabirničkih šina 160A - 630A za vertikalnu i horizontalnu montažu - 35kA**

	Širina (mm)	Pak.	Šifra
Nosač sabirničkih šina 4P		1	<b>UC820</b>
Poklopac za sabirničke šine 990mm za UC820		1	<b>UC827</b>
Perforirani nosač za UC820	250	1	<b>UC811</b>
Perforirani nosač za UC820	500	1	<b>UC812</b>
Perforirani nosač za UC820	750	1	<b>UC813</b>



UC826

**Nosač sabirničkih šina 250A - 630A za vertikalnu i horizontalnu montažu - 17,5kA**

	Širina (mm)	Pak.	Šifra
Nosač sabirničkih šina 4P		1	<b>UC826</b>
Poklopac za sabirničke šine 990mm za UC826		1	<b>UC828</b>
Perforirana montažna šina	450	1	<b>FN875E</b>
Perforirana montažna šina	700	1	<b>FN877E</b>
Perforirana montažna šina	900	1	<b>FN879E</b>



UC817 + FN971E

**Nosač sabirničkih šina 400A - 1250A za vertikalnu i horizontalnu montažu - 35kA**

	Dubina (mm)	Širina (mm)	Pak.	Šifra
Nosač sabirničkih šina 4P			1	<b>UC817</b>
Poklopac za sabirničke šine 400mm za UC817 kod horizontalne montaže			1	<b>UC846</b>
Poklopac za sabirničke šine 400mm za UC817 kod vertikalne montaže			1	<b>UC836</b>
Nosač sabirnica	600		1	<b>FN971E</b>
Nosač sabirnica	800		1	<b>FN972E</b>
Perforirana montažna šina		450	1	<b>FN875E</b>
Perforirana montažna šina		700	1	<b>FN877E</b>
Perforirana montažna šina		900	1	<b>FN879E</b>

**Nosač sabirničkih šina 630A - 4000A za vertikalnu i horizontalnu montažu - 70kA**

	Dubina (mm)	Pak.	Šifra
Nosač sabirničkih šina 4P, 600 do 1600A		1	<b>UC818</b>
Nosač sabirnica	600	1	<b>FN971E</b>
Nosač sabirnica	800	1	<b>FN972E</b>



UC818 + FN971E

**Nosač sabirničkih šina 700A - 3200A za vertikalnu i horizontalnu montažu**

	Pak.	Šifra
Nosač sabirničkih šina 3P, 700 do 3200A	1	<b>UC823</b>
Nosač sabirničkih šina 4P, 700 do 3200A	1	<b>UC824</b>
Nosač sabirnica 3P, plastični vertikalni za UC823	1	<b>UC822</b>
Nosač sabirnica 3P, plastični vertikalni za UC824	1	<b>UC825</b>



UC824

**Dodaci za nosače sabirničkih šina**

	Pak.	Šifra
Višenamjenski nosač	1	<b>UC821</b>



UC821

**Nosač sabirničkih šina 700A - 4000A za vertikalnu i horizontalnu montažu**

	Pak.	Šifra
Nosač sabirničkih šina 4P, 1 do 4 šine debljine 5mm	1	<b>UC895E</b>
Nosač sabirničkih šina 4P, 1 do 2 šine debljine 10mm	1	<b>UC896E</b>
Nosač sabirničkih šina 4P, 1 do 3 šine debljine 10mm	1	<b>UC897E</b>
Aluminijski perforirani profil za UC89xE, dužine 2000mm (1 set 2 komada)	1 set	<b>UC860E</b>
Čelični nosači za fiksiranje UC860E (1 set 10 komada)	1 set	<b>UC861E</b>
Rezervni set za montažu (1 set 6 komada)	1 set	<b>UC862E</b>

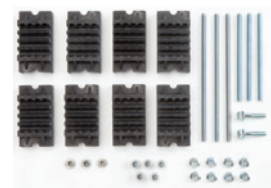

UC895E

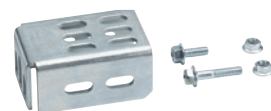

UC861E



KS72B



UC833

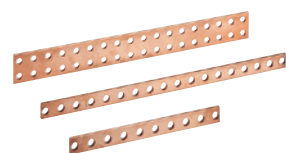

UT87G - UT87B - UT87A



UM30A3



UM30A4



UC844



UC968

### Perforirane bakarne šine

	Š x V (mm)	Vijci		Dužina (mm)	Pak.	Šifra
160A	12 x 5	M5	160A	245	1	<b>KS72B</b>
				1000	1	<b>KS72C</b>
250A	20 x 5	M6/M10	250A	1000	1	<b>UC832</b>
		M6	250A	1750	1	<b>UC833</b>
320A	25 x 5	M10	320A	400	1	<b>UT87A</b>
				700	1	<b>UT87B</b>
				900	1	<b>UT87C</b>
				1000	1	<b>UT87D</b>
				1750	1	<b>UT87E</b>
400A	32 x 5	M6/M10	400A	1000	1	<b>UC842</b>
		M6	400A	1750	1	<b>UC843</b>
		M6/M10	400A	280	1	<b>UM30A3</b>
		M6/M10	400A	430	1	<b>UM30A1</b>
		M6/M10	400A	880	1	<b>UM30A2</b>
630A	30 x 10	M6/M10	630A	430	1	<b>UM30A4</b>
				880	1	<b>UM30A5</b>
770A	50 x 5	M10	770A	400	1	<b>UT87F</b>
				700	1	<b>UT87G</b>
				900	1	<b>UT87H</b>
				1000	1	<b>UT87J</b>
700A - 4000A	50 x 5	M10	770A	1750	1	<b>UC844</b>
	63 x 5	M10	950A	1750	1	<b>UC922</b>
	80 x 5	M10	1170A	1750	1	<b>UC966</b>
	100 x 5	M10	1430A	1750	1	<b>UC967</b>
	125 x 5	M10	1720A	1750	1	<b>UC968</b>
	50 x 10	M10	1050A	1750	1	<b>UC844E</b>
	60 x 10	M10	1210A	1750	1	<b>UC922E</b>
	80 x 10	M10	1525A	1750	1	<b>UC966E</b>
100 x 10	M10	1835A	1750	1	<b>UC967E</b>	



UT88A



UT88B

### Spojni uglovi i konektori UT87x

Opis	Pak.	Šifra
Ugaoni bakreni spoj 25x5mm	1	<b>UT88A</b>
Ugaoni bakreni spoj 50x5mm	1	<b>UT88B</b>
Perforirana bakrena pločica 25x5	1	<b>UT88C</b>
Perforirana bakrena pločica 50x5	1	<b>UT88D</b>

### Izolovane bakarne šine

	Nazivna struja	Dužina (mm)	Pak.	Šifra
20 x 2	160A	2000	1	<b>UM92X</b>
20 x 3	250A	2000	1	<b>UM92Y</b>
32 x 4	400A	2000	1	<b>UM92Z</b>
32 x 6	630A	2000	1	<b>UM92W</b>
40 x 6	800A	2000	1	<b>UM92V</b>
24 x 5	510A	2000	1	<b>UM92ZE</b>
24 x 8	670A	2000	1	<b>UM92WE</b>
40 x 8	1040A	2000	1	<b>UM92VE</b>



UM92ZE

### Dodaci

#### Set kablova 4P

	Pak.	Šifra
za x160 ili za HAxxx sa FID blokom	1	<b>UC870</b>
za x250/h250 sa UC820, vertikalna montaža	1	<b>UC879</b>
za x250/h250 sa UC820, horizontalna montaža	1	<b>UC875</b>
za x250/h250 sa UC826, horizontalna montaža	1	<b>UC869</b>
za x250/h250 sa svim nosačima sabirnica, horizontalna/vertikalna montaža	1	<b>UC871</b>



UC879

#### Set kablova 4P za rastavne prekidače

	Pak.	Šifra
za HAxxx sa distributivnim blokom 20x3mm, 250A	1	<b>UC874</b>
za HAxxx sa UC830 20x3mm, 250A	1	<b>UC876</b>



UC876

### Bakarne šine za uzemljenje i sabirnice za spajanje vodiča

#### Šine za uzemljenje 160A

	Dužina (mm)	Pak.	Šifra
12 x 5	250	1	<b>UC971</b>
	500	1	<b>UC972</b>



UC971



#### Sabirnice za spajanje PE vodiča odlaznih kablova

	Dužina (mm)	Pak.	Šifra
12 x 5 sa 1 x K158	250	1	<b>UC975</b>
12 x 5 sa 2 x K158	500	1	<b>UC976</b>
12 x 5 sa 2 x K158	750	1	<b>UC978</b>



UC976

#### QuickConnect Sabirnice za spajanje PE vodiča odlaznih kablova

	Dužina (mm)	Pak.	Šifra
sa 1 QC blokom 	250	1	<b>UC975S</b>
sa 2 QC bloka 	500	1	<b>UC976S</b>
sa 2 QC bloka 	750	1	<b>UC978S</b>



UC975S

#### Kablovi za uzemljenje

	Dužina (mm)	Pak.	Šifra
Presjek 25mm <sup>2</sup> , M8 i M6	300	1	<b>UZ009</b>
Presjek 25mm <sup>2</sup> , M8	560	1	<b>UZ012</b>



UZ009

UZ012

**Dodaci za quadro5 / quadro plus ormare**



UC851

**Vijci**

	Pak.	Šifra
Vijak sa podloškom M6 x 10mm	50	<b>UC851</b>
Vijak sa podloškom M8 x 30mm	1	<b>UC853</b>
Vijak sa podloškom M10 x 30mm	1	<b>UC855</b>



KS24C

**Stezaljke za bakarne šine**

	Pak.	Šifra
za šine 12 / 20 / 25 / 30x5mm, 1,5 - 16mm <sup>2</sup>	1	<b>K96Q</b>
za šine 12 / 20 / 25 / 30x5mm, 1,5 - 35mm <sup>2</sup>	1	<b>K96T</b>
za šine 12 / 20 / 25 / 30x5mm, 1,5 - 50mm <sup>2</sup>	1	<b>K96D</b>
za šine 12 / 20 / 25 / 30x5mm, 16 - 70mm <sup>2</sup>	1	<b>K96V</b>
za šine 12x5 / 10mm, 25 - 95mm <sup>2</sup>	1	<b>K96H</b>
za šine 12 / 20 / 25 / 30 / 32x5mm, 16 - 120mm <sup>2</sup>	1	<b>K96W</b>
za šine 12 / 20 x 5 / 10mm, 50 - 150mm <sup>2</sup>	1	<b>K96K</b>
za šine 20 / 25 / 30 / 32x5 / 10mm, 95 - 185mm <sup>2</sup>	1	<b>KS24C</b>
za šine 20 / 25 / 30 / 32x5 / 10mm, 150 - 300mm <sup>2</sup>	1	<b>KS30C</b>

**Izolatori i dodaci**



50315008

**Izolatori**

	Visina (mm)	Prečnik (mm)	Pak.	Šifra
M6	35	33	1	<b>50313506</b>
M8	50	46	1	<b>50315008</b>
M10	65	55	1	<b>50316510</b>
M6, sa 1 vijkom bez glave	25	21	1	<b>50362506</b>
M8, sa 1 vijkom bez glave	50	46	1	<b>50365008</b>
M10, sa 1 vijkom bez glave	60	55	1	<b>50366012</b>
M6, sa 2 vijka bez glave	25	21	1	<b>50372506</b>
M8, sa 2 vijka bez glave	50	46	1	<b>50375008</b>
M10, sa 2 vijka bez glave	60	55	1	<b>50376012</b>

**Dodaci izolatora**

	Pak.	Šifra
Vijak bez glave M6 x 30mm	1	<b>50323006</b>
Vijak bez glave M8 x 30mm	1	<b>50324008</b>
Vijak bez glave M10 x 30mm	1	<b>50324010</b>
Matica M6	1	<b>1MA2121</b>
Matica M8	1	<b>1MA2124</b>
Matica M10	1	<b>200677800</b>
Matica M12	1	<b>1MA2126</b>

## Perforirani kanali

### Perforirani kanali sa poklopcem

	Š x V x Dužina (mm)	Pak.	Šifra
vertikalna montaža	60 x 80 x 2000	1	<b>UC916</b>
horizontalna montaža	30 x 80 x 250	1	<b>UC911</b>
	30 x 80 x 500	1	<b>UC912</b>
	30 x 80 x 750	1	<b>UC913</b>
	30 x 80 x 2000	1	<b>UC917</b>



UC916 UC912

### Nosač perforiranih kanala

	Pak.	Šifra
za kanale horizontalno/vertikalno montirane	1	<b>UC915</b>



UC915

## Držači kablova

### Setovi držača kablova

	Pak.	Šifra
Držači kablova manjeg kapaciteta (1 set 20 komada)	1 set	<b>UZ25V2</b>
Držači kablova većeg kapaciteta (1 set 20 komada)	1 set	<b>UZ25V1</b>



UZ25V1

### Adapter za držače kablova

	Pak.	Šifra
za UZ25V2 i UZ25V1 (1 set 20 komada)	1 set	<b>UZ01V1</b>



UZ01V1

## Pribor i dijelovi

### Višenamjenski perforirani nosači

Širina (mm)	Pak.	Šifra
185	1	<b>UC288</b>
250	1	<b>UC988</b>
500	1	<b>UC289</b>
750	1	<b>UC989</b>

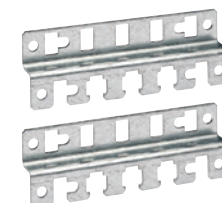

UC288

### Poklopci za zatvaranje modularnog otvora

	Pak.	Šifra
10 modula, bijela RAL9010	1	<b>JP003</b>
24 modula, bijela RAL9010	1	<b>JP024</b>



JP003

### Trake za natpise

	Pak.	Šifra
10 modula	1	<b>JE001</b>
24 modula	1	<b>JE003</b>



JE003

### Ostali pribor

Opis	Pak.	Šifra
Sigurnosne matice M6	25	<b>UC990</b>
Vijci M6 x12mm	25	<b>UC991</b>
Metalni distancer M6 dužine 80mm	1	<b>UC992</b>
Vijci M6 x 10mm (samo za quadro plus) (1 set 25 komada)	1 set	<b>UC856E</b>
Prednja ploča sa osvjetljenjem LED 3W, 230V (V 75 x Š 600mm)	1	<b>UC230X10</b>



UC990



**kompletan FK  
ormar sa vratima,  
montažnom pločom  
i postoljem**



**unutrašnja vrata**



	Dimenzije (mm)			FK razvodni ormar sa vratima, montažnom pločom i postoljem	FK razvodni ormar sa prozirnim vratima, montažnom pločom i postoljem	Unutrašnja vrata
	Visina	Širina	Dubina			
1	1400	600	400	<b>FK093</b>	-	-
2	1400	800	400	<b>FK094</b>	-	-
3	1600	600	400	<b>FK103</b>	-	-
4	1600	800	400	<b>FK104</b>	-	-
5	1600	1000	400	<b>FK105</b>	-	-
6	1900	600	400	<b>FK110</b>	-	<b>FK020</b>
7	1900	800	400	<b>FK120</b>	-	<b>FK030</b>
8	1900	1000	400	<b>FK130</b>	<b>FK130T</b>	<b>FK040</b>
9	1900	600	500	<b>FK111</b>	<b>FK111T</b>	<b>FK020</b>
10	1900	800	500	<b>FK121</b>	<b>FK121T</b>	<b>FK030</b>
11	1900	1000	500	<b>FK131</b>	<b>FK131T</b>	<b>FK040</b>
12	2100	600	400	<b>FK113</b>	<b>FK113T</b>	<b>FK021</b>
13	2100	800	400	<b>FK123</b>	<b>FK123T</b>	<b>FK031</b>
14	2100	1000	400	<b>FK133</b>	<b>FK133T</b>	<b>FK041</b>
15	2100	600	500	<b>FK114</b>	<b>FK114T</b>	<b>FK021</b>
16	2100	800	500	<b>FK124</b>	<b>FK124T</b>	<b>FK031</b>
17	2100	1000	500	<b>FK134</b>	<b>FK134T</b>	<b>FK041</b>

donji poklopac - puni



donji poklopac - pomični otvor



bočne stranice



dodatno postolje



bočni perforirani nosači

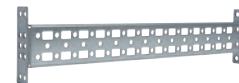

	Donji poklopac - puni	Donji poklopac - pomični otvor	Bočne stranice	Dodatno postolje	Bočni perforirani nosači
	FK220	FK270	FK293	-	-
	FK230	FK280	FK293	-	-
	FK220	FK270	FK205	-	-
	FK230	FK280	FK205	-	-
	FK240	FK290	FK205	-	-
	FK220	FK270	FK310	FK370	F404
	FK230	FK280	FK310	FK380	F404
	FK240	FK290	FK310	FK390	F404
	FK220	FK270	FK311	FK371	F405
	FK230	FK280	FK311	FK381	F405
	FK240	FK290	FK311	FK391	F405
	FK220	FK270	FK320	FK370	F404
	FK230	FK280	FK320	FK380	F404
	FK240	FK290	FK320	FK390	F404
	FK220	FK270	FK321	FK371	F405
	FK230	FK280	FK321	FK381	F405
	FK240	FK290	FK321	FK391	F405

### FK samostojeći ormari

- Jednodijelni ormari sa postoljem od 100 mm
- Materijal pocinčani čelični lim debljine:
  - gornji dio i bočne stranice 1,5 mm
  - postolje 1,2 mm
  - montažna ploča 2 mm
  - vrata 1,5 mm
- Kompletan razvodni ormar sa vratima, temeljnom pločom i postoljem

- Moguće 4 vrste zaključavanja, trouglasta brava kao standardna vrsta zaključavanja

### Karakteristike:

- Zaštita IP65, zaštita od udaraca IK10
- Zaštitna klasa I
- Dimenzije: od 1400 x 600 x 400 mm do 2100 x 1000 x 500 mm
- Boja: siva RAL7035

- Dodaci: donji poklopac puni, donji poklopac sa pomičnim otvorom, bočne stranice, postolje od 100 mm i set za povezivanje dva ormara



FK114



FK093

### FK kompletni razvodni ormari sa montažnom pločom i postoljem i prozirnim/punim vratima

Opis	Dimenzije V x Š x D (mm)	Vrata	Pak.	Šifra
Kompletan FK ormar	1400 x 600 x 400	puna	1	<b>FK093</b>
Kompletan FK ormar	1400 x 800 x 400	puna	1	<b>FK094</b>
Kompletan FK ormar	1600 x 600 x 400	puna	1	<b>FK103</b>
Kompletan FK ormar	1600 x 800 x 400	puna	1	<b>FK104</b>
Kompletan FK ormar	1600 x 1000 x 400	puna	1	<b>FK105</b>
Kompletan FK ormar	1900 x 600 x 400	puna	1	<b>FK110</b>
Kompletan FK ormar	1900 x 800 x 400	puna	1	<b>FK120</b>
Kompletan FK ormar	1900 x 1000 x 400	puna	1	<b>FK130</b>
Kompletan FK ormar	1900 x 1000 x 400	prozima	1	<b>FK130T</b>
Kompletan FK ormar	1900 x 600 x 500	puna	1	<b>FK111</b>
Kompletan FK ormar	1900 x 600 x 500	prozima	1	<b>FK111T</b>
Kompletan FK ormar	1900 x 800 x 500	puna	1	<b>FK121</b>
Kompletan FK ormar	1900 x 800 x 500	prozima	1	<b>FK121T</b>
Kompletan FK ormar	1900 x 1000 x 500	puna	1	<b>FK131</b>
Kompletan FK ormar	1900 x 1000 x 500	prozima	1	<b>FK131T</b>
Kompletan FK ormar	2100 x 600 x 400	puna	1	<b>FK113</b>
Kompletan FK ormar	2100 x 600 x 400	prozima	1	<b>FK113T</b>
Kompletan FK ormar	2100 x 800 x 400	puna	1	<b>FK123</b>
Kompletan FK ormar	2100 x 800 x 400	prozima	1	<b>FK123T</b>
Kompletan FK ormar	2100 x 1000 x 400	puna	1	<b>FK133</b>
Kompletan FK ormar	2100 x 1000 x 400	prozima	1	<b>FK133T</b>
Kompletan FK ormar	2100 x 600 x 500	puna	1	<b>FK114</b>
Kompletan FK ormar	2100 x 600 x 500	prozima	1	<b>FK114T</b>
Kompletan FK ormar	2100 x 800 x 500	puna	1	<b>FK124</b>
Kompletan FK ormar	2100 x 800 x 500	prozima	1	<b>FK124T</b>
Kompletan FK ormar	2100 x 1000 x 500	puna	1	<b>FK134</b>
Kompletan FK ormar	2100 x 1000 x 500	prozima	1	<b>FK134T</b>



FK031

### Unutrašnja vrata

Opis	Dimenzije V x Š (mm)	Pak.	Šifra
Unutrašnja vrata	1900 x 600	1	<b>FK020</b>
Unutrašnja vrata	1900 x 800	1	<b>FK030</b>
Unutrašnja vrata	1900 x 1000	1	<b>FK040</b>
Unutrašnja vrata	2100 x 600	1	<b>FK021</b>
Unutrašnja vrata	2100 x 800	1	<b>FK031</b>
Unutrašnja vrata	2100 x 1000	1	<b>FK041</b>

**Donji poklopci - puni**

Za ormare Š x D (mm)	Pak.	Šifra
600 x 400 / 500	1	<b>FK220</b>
800 x 400 / 500	1	<b>FK230</b>
1000 x 400 / 500	1	<b>FK240</b>



FK220

**Donji poklopci - pomični otvor**

Za ormare Š x D (mm)	Pak.	Šifra
600 x 400 / 500	1	<b>FK270</b>
800 x 400 / 500	1	<b>FK280</b>
1000 x 400 / 500	1	<b>FK290</b>



FK270

**Bočne stranice (2 komada)**

Za ormare V x D (mm)	Pak.	Šifra
1400 x 400	1	<b>FK293</b>
1600 x 400	1	<b>FK205</b>
1900 x 400	1	<b>FK310</b>
1900 x 500	1	<b>FK311</b>
2100 x 400	1	<b>FK320</b>
2100 x 500	1	<b>FK321</b>



FK321

**Dodatna postolja visine 100 mm**

Za ormare Š x D (mm)	Pak.	Šifra
600 x 400	1	<b>FK370</b>
800 x 400	1	<b>FK380</b>
1000 x 400	1	<b>FK390</b>
600 x 500	1	<b>FK371</b>
800 x 500	1	<b>FK381</b>
1000 x 500	1	<b>FK391</b>



FK380

**Bočni perforirani nosači**

Za ormare dubine (mm)	Pak.	Šifra
400	1	<b>FK404</b>
500	1	<b>FK405</b>



FK404



FM635

**Set za povezivanje ormara**

Opis	Pak.	Šifra
Set za povezivanje dva ormara	1	<b>FM635</b>



FN951

**Samoljepljiva traka za zadržavanje zaštite IP65 pri spajanju dva ormara**

Opis	Pak.	Šifra
Samoljepljiva traka	1	<b>FN951</b>



FK460

**Set za montažu na zid**

Opis	Pak.	Šifra
Nosači za montažu FK ormara na zid	1	<b>FK460</b>



FM653

**Set za transport ormara**

Opis	Pak.	Šifra
Set 4 dijela	1	<b>FM653</b>



FZ517

**Dodatna brava za zamjenu (standardni uložak)**

Opis	Pak.	Šifra
Trouglasta brava	1	<b>10962</b>
Dvobrada brava	1	<b>FZ516</b>
Četverouglasta brava	1	<b>FZ517</b>



FZ680

**Brava zakretna**

Opis	Pak.	Šifra
Zakretna brava za naknadno montiranje (bez cilindra)	1	<b>FZ680</b>



FL76Z

**Cilindri i brava sa ključem**

Opis	Pak.	Šifra
Cilindar trokut	1	<b>FZ74Z</b>
Cilindar dvobradi	1	<b>FZ75Z</b>
Cilindar 8 x 8	1	<b>FZ76Z</b>
Brava sa ključem	1	<b>FL98Z</b>

hagercad

# Planirajte sa lakoćom

Sa hagercad, možete brzo i jednostavno kreirati višepolne ili jedнопolne šeme: rasvjeta, upravljanje grijanjem, KNX i od sada uređaji za komunikaciju vrata.

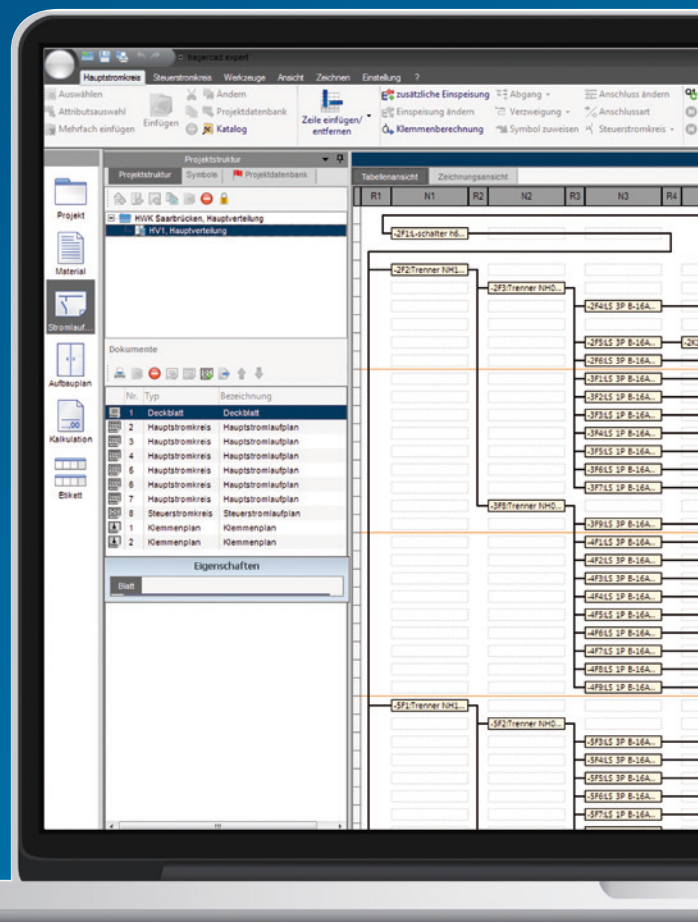

:hager

Univers FWB

Razvodni ormari

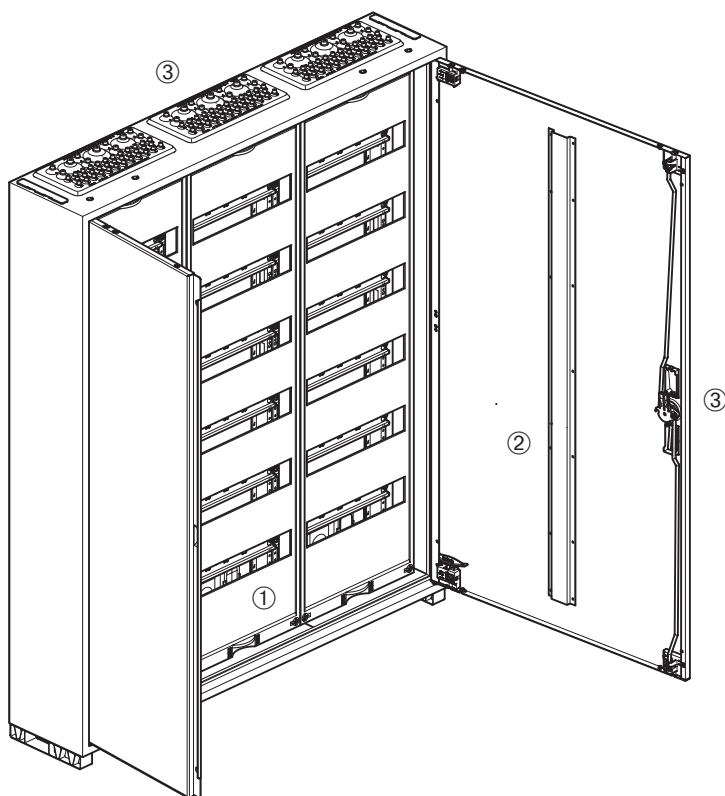

Univers ormari

- Zaštitna klasa II
- Zaštita IP30 (bez vrata), IP44 (puna vrata)
- Nisu pogodni za ugradnju u rigips
- Visina: 500 do 1100 mm
- Širina: 1 do 4 polja
- Dubina: 161 mm
- Boja: čista bijela RAL9010

Sastoje se od:

① Kućišta

- Čelični lim, praškasto ofarbano
- Moguće "stack" (slagati) jedan na drugi

② Vrata

- Čelični lim, praškasto ofarbano
- Ravna sa kućištem
- Demontaža moguća bez alata
- Podesivi šarnjiri
- Ugao otvaranja vrata 110°
- Ormari sa 3 i 4 polja imaju 2 vrata
- Zaštita od udaraca / mehaničkih oštećenja IK09 (puna vrata)

③ Zaključavanje vrata

- Zaključavanje u 3 pozicije
- Priprema za plombiranje (IP44)
- Moguće montiranje različitih brava

Norme i standardi

- Ispitano prema VDE 0660 dio 600, -1, -2, -3 
- Dimenzije prema DIN 43870
- Zaštita IP30 / IP44 / IP54 prema VDE 0470 dio 1
- Zaštita IP3X kod otvorenih vrata
- Otvori za zrak prema VDE 0110, dio 1 i 2
- Stepen zagađenja 3
- Zaštitno izolovani
- AC 230/400V, 50Hz
- Ugradnja uređaja do 125A
- Kategorija odvodnika III kod univers N
- Kategorija odvodnika IV kod univers Z

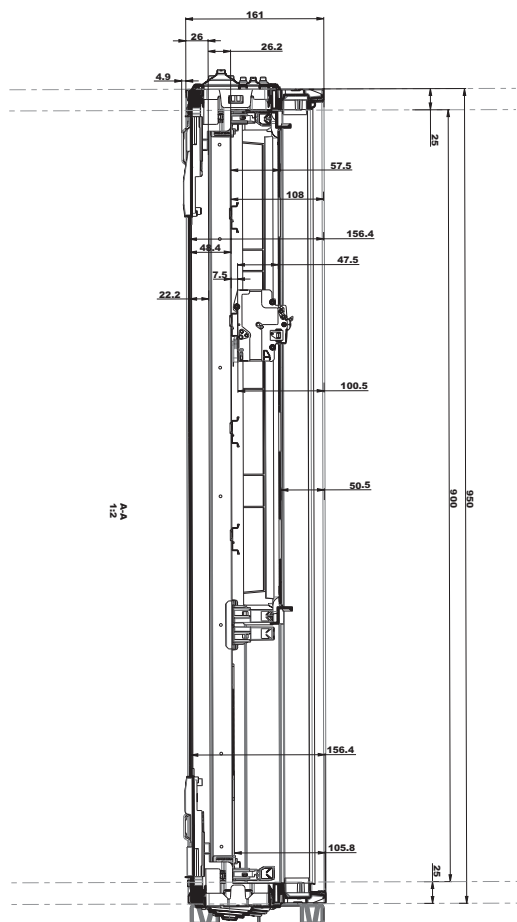

FWB nadgradni ormari

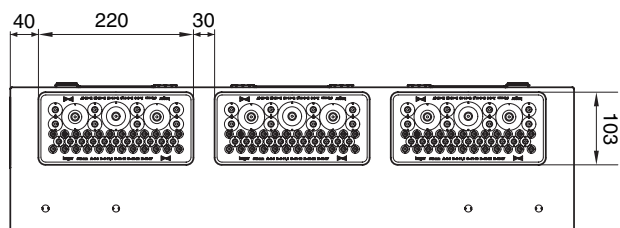
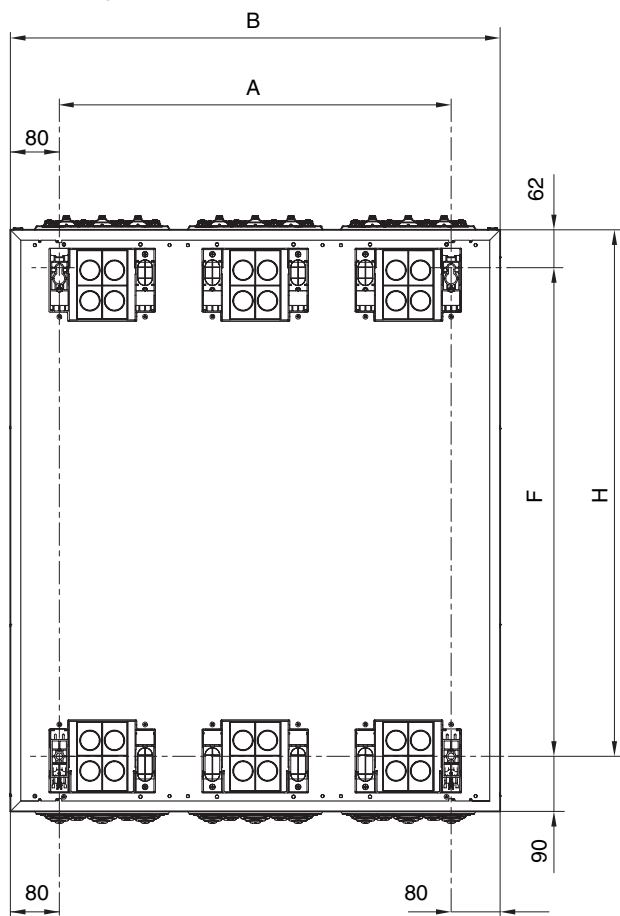

Dimenzije (mm)

Šifra	Dimenzije ormara (mm)		Dimenzije pričvršćivanja (mm)	
	H	B	A	F
FWB31	500	300	348	140
FWB32	500	550	348	390
FWB33	500	800	348	640
FWB34	500	1050	348	890
FWB41	650	300	498	140
FWB42	650	550	498	390
FWB43	650	800	498	640
FWB44	650	1050	498	890
FWB51	800	300	648	140
FWB52	800	550	648	390
FWB53	800	800	648	640
FWB54	800	1050	648	890
FWB61	950	300	798	140
FWB62	950	550	798	390
FWB63	950	800	798	640
FWB64	950	1050	798	890
FWB71	1100	300	948	140
FWB72	1100	550	948	390
FWB73	1100	800	948	640
FWB74	1100	1050	948	890



FWU ugradni ormari

Razvodni ormari

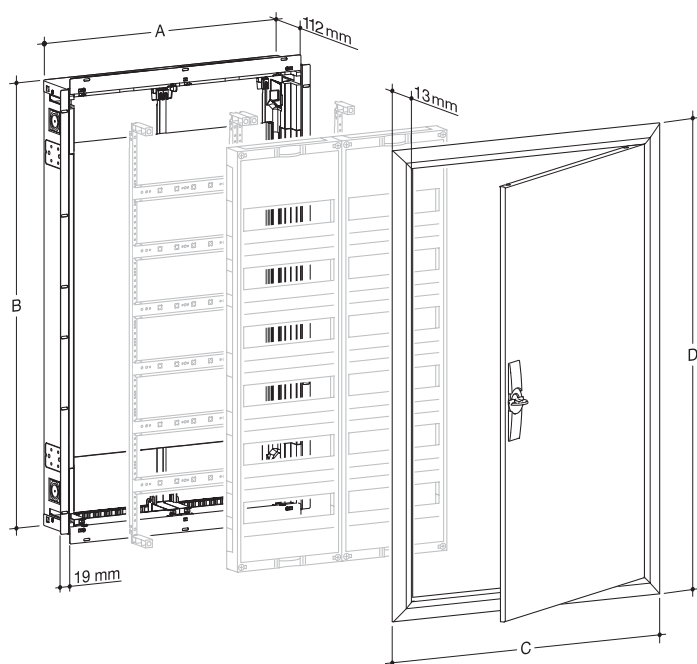

Dimenzije (mm)

Šifra	Dimenzije ormara (mm)		Dimenzije pričvršćivanja (mm)	
	A	B	C	D
FWU31	310	502	353	553
FWU32	560	502	603	553
FWU33	810	502	853	553
FWU41	310	652	353	703
FWU42	560	652	603	703
FWU43	810	652	853	703
FWU51	310	802	353	853
FWU52	560	802	603	853
FWU53	810	802	853	853
FWU61	310	952	353	1003
FWU62	560	952	603	1003
FWU63	805	952	853	1003
FWU71	310	1102	353	1153
FWU72	560	1102	603	1153
FWU73	810	1102	853	1153
FWU81	310	1252	353	1303

Izbacivanje multimedijalnog polja i instalacija poklopca i dodatka u svrhu ostvarivanja zaštitne klase II  
Za korištenje vodiča koji nemaju duplu ili pojačanu izolaciju.

	UN0..FN	UZ03A1	UZ01A2	UZ04A1	UZ..1M..	US31A1	US41A1	US51A1
<b>FW3...</b>	1xUN03FN	2x	4x		1xUZ31M5/M6	1x		
<b>FW4...</b>	1xUN04FN	2x	4x		1xUZ41M5/M6		1x	
<b>FW5...</b>	1xUN05FN	2x	4x		1xUZ51M5/M6			1x
<b>FW6...</b>	1xUN06FN	2x	4x	2x	2xUZ31M5/M6	2x		
<b>FW7...</b>	1xUN07FN	2x	4x	2x	1xUZ31M5/M6 1xUZ41M5/M6	1x	1x	

## quadro5 ormari i skice

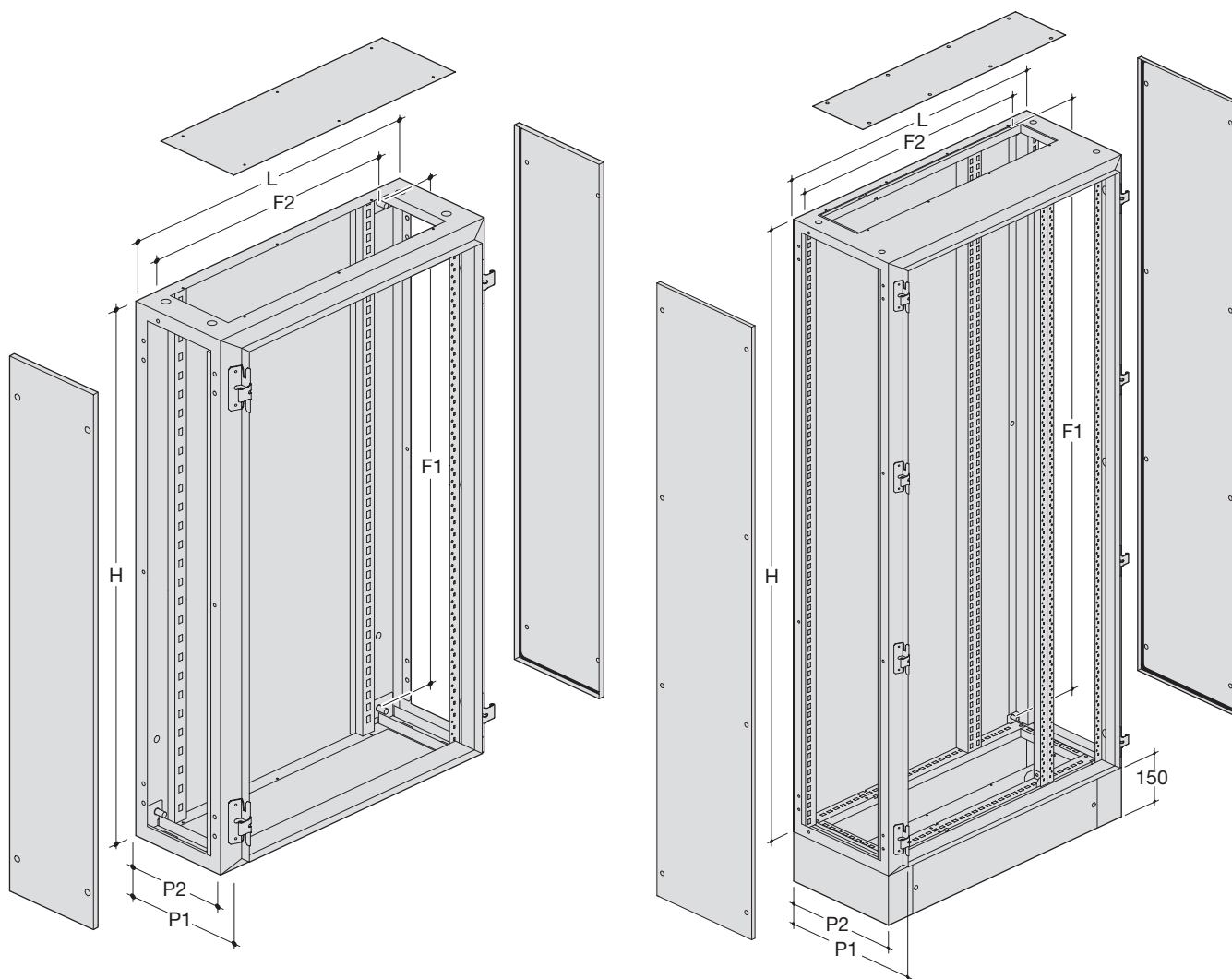

Razvodni ormari

Dimenzije (mm)							
Šifra						Fiksiranje	
Ormar	Stranice	H	L	P1	P2	F1	F2
FM200	FM400	510	700	260	220	430	570
FM201	FM401	660	700	260	220	580	570
FM202	FM402	810	700	260	220	730	570
FM203	FM403	960	700	260	220	880	570
FM204	FM404	1100	700	260	220	1030	570
FM205	FM405	1260	700	260	220	1180	570
FM206	FM406	1410	700	260	220	1330	570

Dimenzije (mm)							
Šifra						Fiksiranje	
Ormar	Stranice	H	L	P1	P2	F1	F2
FM107	FM407	1560	450	260	220	1480	320
FM108	FM408	1710	450	260	220	1630	320
FM109	FM409	1860	450	260	220	1780	320
FM207	FM407	1560	700	260	220	1480	570
FM208	FM408	1710	700	260	220	1630	570
FM209	FM409	1860	700	260	220	1780	570
FM307	FM407	1560	900	260	220	1480	770
FM308	FM408	1710	900	260	220	1630	770
FM309	FM409	1860	900	260	220	1780	770
FM117	FM407	1560	450	400	360	1480	320
FM118	FM408	1710	450	400	360	1630	320
FM119	FM409	1860	450	400	360	1780	320
FM217	FM407	1560	700	400	360	1480	570
FM218	FM408	1710	700	400	360	1630	570
FM219	FM409	1860	700	400	360	1780	570
FM317	FM407	1560	900	400	360	1480	770
FM318	FM408	1710	900	400	360	1630	770
FM319	FM409	1860	900	400	360	1780	770

quadro5 leđa ormara

Razvodni ormari



	Širina (mm)	Udaljenost između nosača (mm)	Stražnja širina (mm)
quadro5	450	250	350
	700	500	600
	900	700	800

	Udaljenost između nosača (mm)	Stražnja širina (mm)
1x10	250	350
1x24	500	600
1x36	700	800

### quadro plus ormari

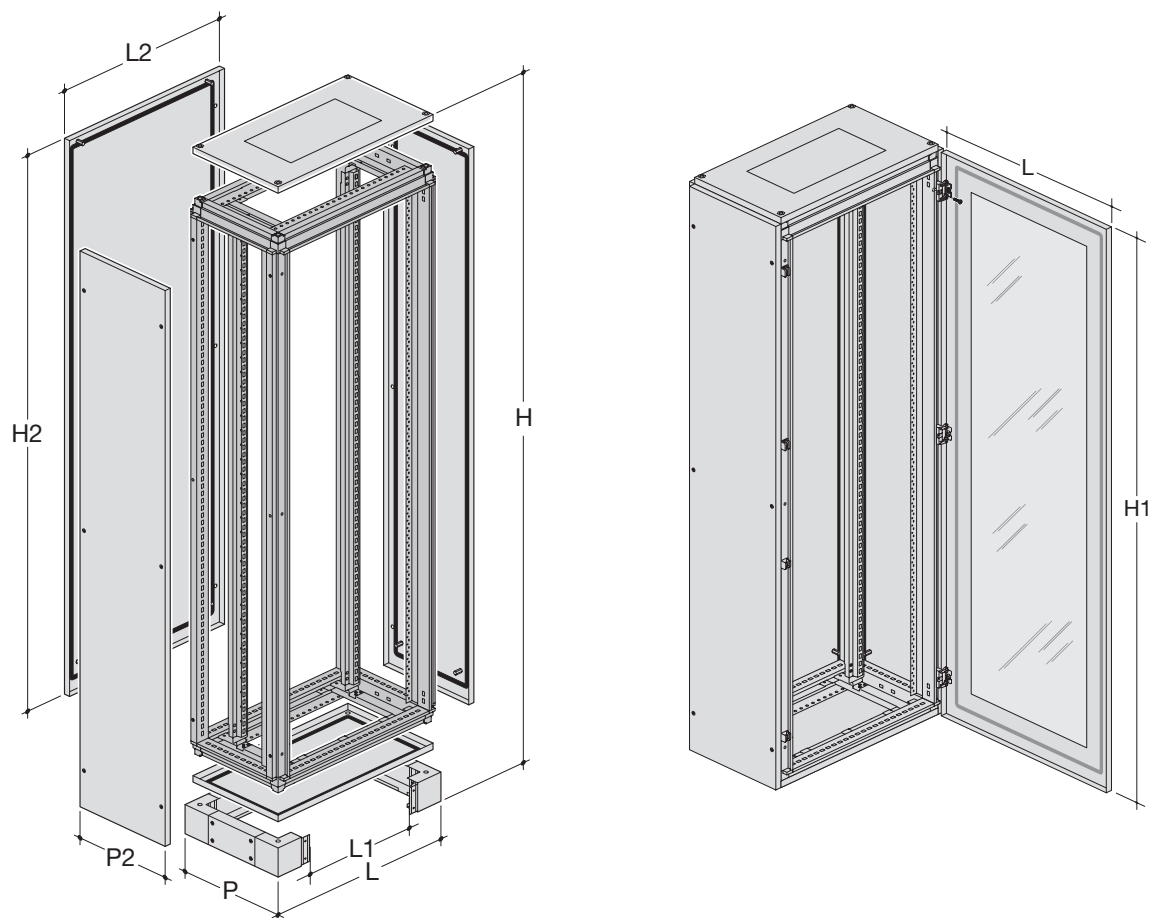

Razvodni ormari

	Gornji/ donji dio	Postolje	Stranice	Leđa	H*	P	L1	H2	L2	P2
L = 450	FN020E	FN440E	FN367E	FN217E	2100	600	288	2000	448	565
L = 700	FN029E	FN451E	FN367E	FN277E	2100	600	538	2000	698	565
L = 900	FN031E	FN453E	FN367E	FN297E	2100	600	738	2000	898	565
L = 450	FN022E	FN442E	FN377E	FN217E	2100	800	288	2000	448	765
L = 700	FN013E	FN433E	FN377E	FN277E	2100	800	538	2000	698	765
L = 900	FN017E	FN437E	FN377E	FN297E	2100	800	738	2000	898	765

### quadro plus leđa ormara

